



TENDE A RULLO

ROLLER BLINDS

MOTTURA

Tende a rullo / Roller blinds

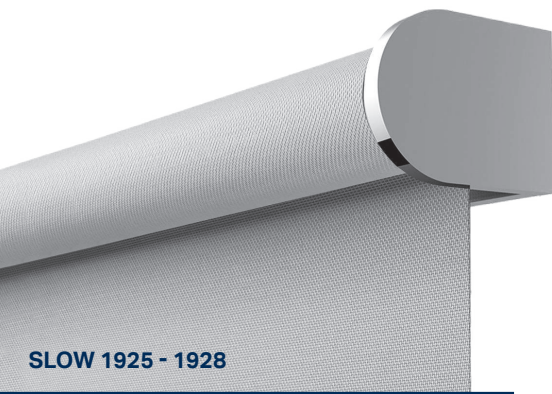

SLOW 1925 - 1928



SIDEWINDER 8220



SIDEWINDER 8236 - PLUS 2139



SIDEWINDER 8243



SIDEWINDER 8277

La tenda rullo è sia un complemento d'arredo di design attuale, che una soluzione per la protezione solare, ottimale sia per il residenziale che per gli ambienti per comunità e horeca.

La possibilità di realizzare le più diverse dimensioni fanno della tenda a rullo una scelta completa e versatile.

Molti sono i sistemi di azionamenti che vanno scelti in base alle caratteristiche ed alla destinazione dell'ambiente in cui vengono installate.

Le **tende a rullo con azionamento a molla decelerata** sono le più indicate per uso in ambiente residenziale in presenza di bambini perché garantiscono la sicurezza più assoluta.

Le **tende a rullo con azionamento a catenella** sono quelle più universali perché possono essere realizzate in piccole dimensioni per finestre e porta finestre o anche in grandi dimensioni in presenza di grandi vetrate quali complementi per il risparmio energetico.

Le **tende a rullo ad azionamento combinato catenella e molla decelerata**. Plus è la versione con comando brevettato a doppio azionamento che offre, allo stesso tempo, la praticità della catenella e la sofisticatezza della molla decelerata.

Le **tende ad argano** sono le più indicate per la loro robustezza per ambienti pubblici come scuole, ospedali o comunità.

Le **tende ad azionamento a motore** sono le più sofisticate ed adatte in ogni ambiente e sono azionabili con telecomandi remoti, smartphone e inseribili in scenari home automation o soluzioni smart home.

Le **tende motorizzate con azionamento a batteria**, oggi disponibili anche per dimensioni medio grandi, sono particolarmente pratiche perché si possono installare senza alcun cablaggio.

HANDLE 1765
ENERGY 471

ENERGY 428 - 440 - 450
ENERGY 728 - 736 - 740



Roller blind is , at the same time, a contemporary design detail of furniture and a solution for optimal sun protection in case of residential and community environments.

The possibility of realizing different wide dimensions of roller blinds make themselves a complete and versatile choice.

There are many versions that might be chosen based according to the environment where they will be installed.

Roller blinds with decelerated spring operation are the most suitable for residential environments in the presence of children as they guarantee the utmost safety.

Chain driven roller blinds are the most universal ones as they may be realized in small dimensions for windows and doors or, even in wide dimensions, as energy saving solution .

Combined chain - decelerated spring operating roller blinds. Plus is the patented twin operated system that offers the chain's comfort combined with a sophisticated decelerated spring. The blind is lowered by as a decelerated spring-operated roller blind, it can stop in any position and is raised by touching the chain.

The **crank operating roller blinds** are the most suitable due to their strengthness for public environments as schools, hospitals or communities.

Motorized blinds are the most suitable sophisticated systems for any environment and can be operated with remote controls, smartphone or integrated into home automation and smart home solutions.

Battery operated motorized blinds, today available for medium large windows too, are very practical as they can be installed wireless.

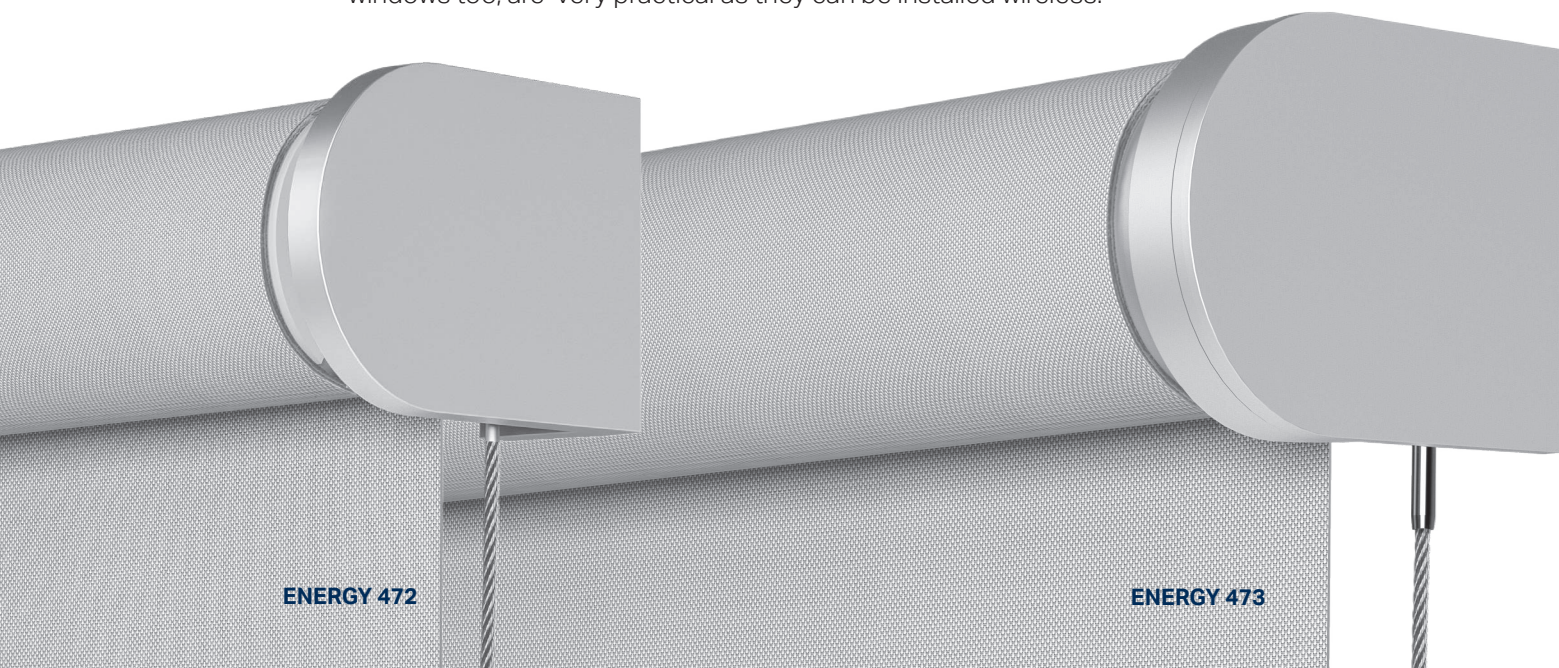

ENERGY 472

ENERGY 473

- SLOW 1925
- SIDEWINDER 8220
- ENERGY 428



ART 1933 - 1935 - 1936

- SIDEWINDER 8220
- ENERGY 728

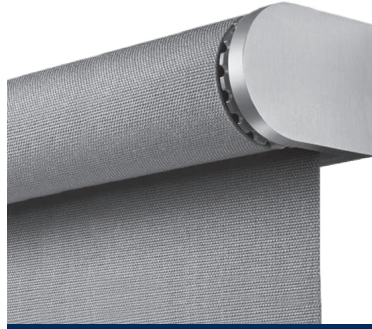

ART 1862 - 1863

- SLOW 1925
- SIDEWINDER 8220

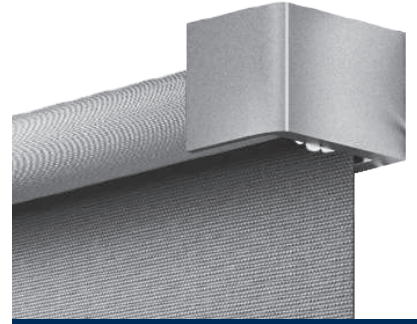

ART 1427

- SIDEWINDER 8236
- SIDEWINDER 8243
- PLUS 2139



ART 1894 - 1895

- SIDEWINDER 8236
- SIDEWINDER 8243
- PLUS 2139



ART 1848 - 1850 - 1852

- SLOW 1928

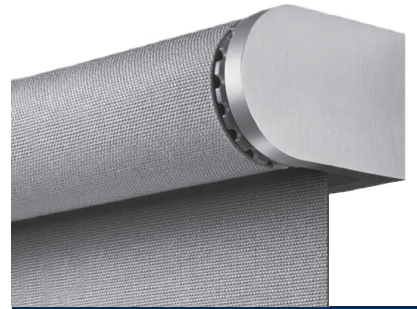

ART 1948 - 1952 - 1966

- SIDEWINDER 8277 - ENERGY 440 - ENERGY 450 - ENERGY 740

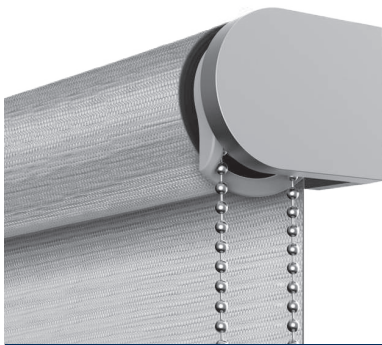

ART 1897 - 1898

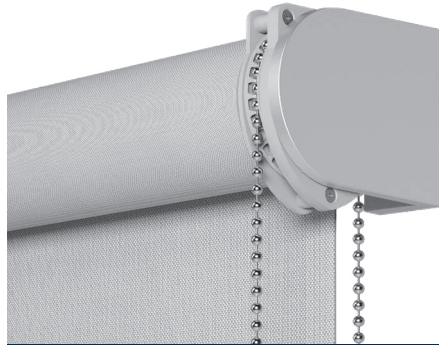

ART 8245

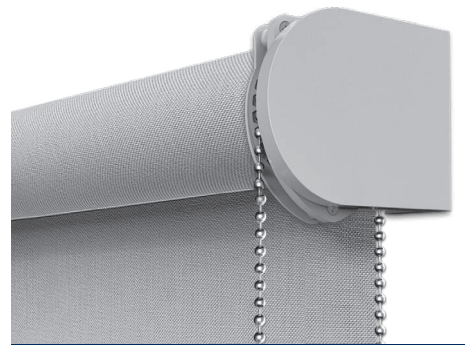

ART 1978 - 1899

- ENERGY 471
- HANDLE 1765

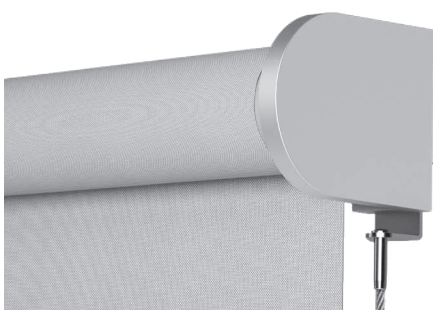

ART 1236

- ENERGY 472

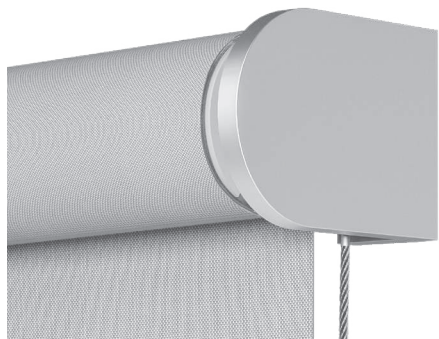

ART 1173

- ENERGY 473

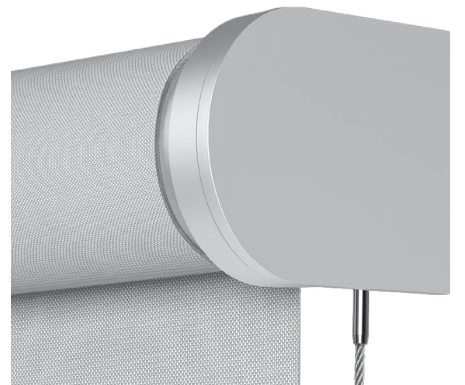

ART 2473



1900EA20

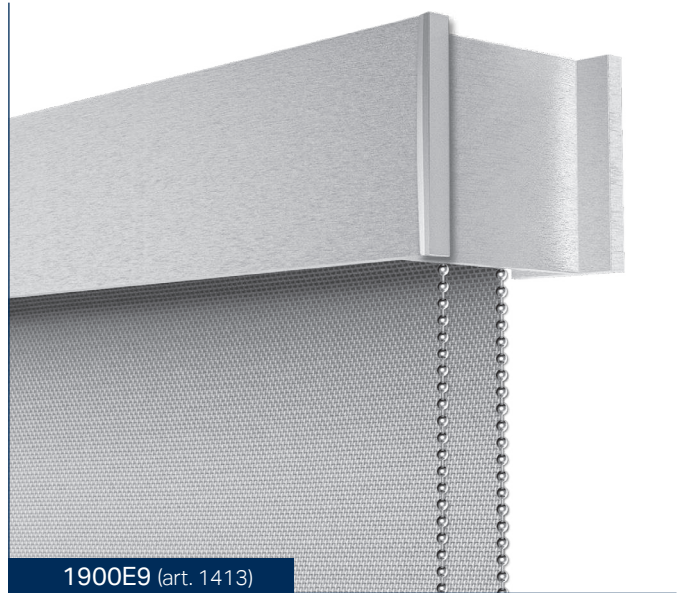

1900E9 (art. 1413)



1900E20



1900E9 (art. 1419)



ART 1190

- SLOW 1928
- PLUS 2139
- SIDEWINDER 8236 - 8243
- HANDLE 1765
- ENERGY 440 - 450 - 736 - 740



ART 1167

- SIDEWINDER 8277
- HANDLE 1765
- ENERGY 440 - 450 - 471 - 472



ART 4166

- SLOW 1925 - 1928
- PLUS 2139
- SIDEWINDER 8220 - 8236 - 8243 - 8277
- HANDLE 1765
- ENERGY 740 - 440 - 450

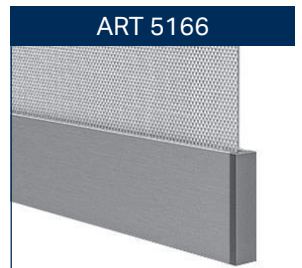

ART 5166

- SLOW 1928
- PLUS 2139
- SIDEWINDER 8236 - 8243 - 8277
- HANDLE 1765
- ENERGY 740 - 440 - 450 - 472



ART 1912

- SLOW 1925
- SIDEWINDER 8220
- ENERGY 428 - 728

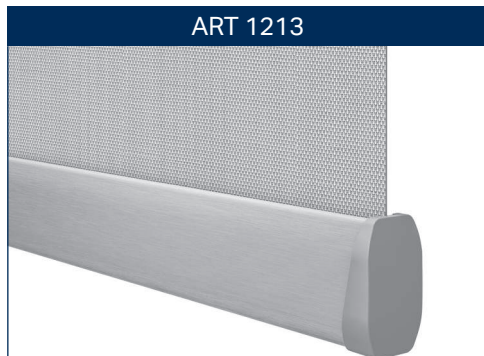

ART 1213

- ENERGY 472 - 473

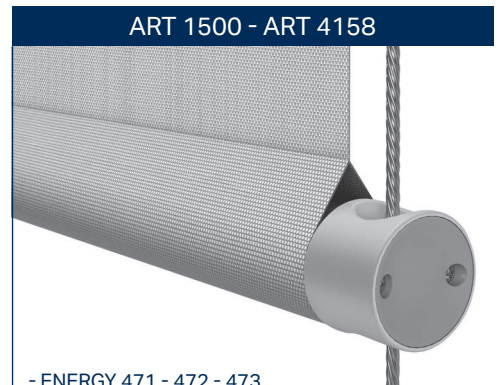

ART 1500 - ART 4158

- ENERGY 471 - 472 - 473



SERIE 75



SERIE 79

Rollbox 75 e 79 sono due prodotti ad uso indoor in cui si integrano tecnologia e design. La linea di entrambi i prodotti permette di interpretare Rollbox 75 e 79 non solo come sistemi per la protezione solare, ma complementi d'arredo dalla forte personalità.

Per quanto riguarda gli azionamenti la gamma è così composta:

- Rollbox 175 e 179 - azionamento a molla decelerata
- Rollbox 275 - azionamento a catenella
- Rollbox 475 e 479 - azionamento a motore 230 Vac
- Rollbox 775 e 779 - azionamento a batteria Lion integrata

I colori di serie sono bianco Ral 9016, anodizzato argento satinato e cromato; su richiesta qualsiasi altro colore.

L'installazione può essere, indifferentemente, a parete o a soffitto.



Rollbox 75 and 79 are two boxed roller blinds for indoor use in which technology and design are integrated. The line of both products allows Rollbox 75 and 79 to be interpreted not only as sun protection systems, but as furnishing accessories with a strong personality.

As for the operations, the range is available as follows:

- Rollbox 175 and 179 - decelerated spring operation
- Rollbox 275 - chain operation
- Rollbox 475 and 479 - 230Vac motor drive control
- Rollbox 775 and 779 - rechargeable integrated Li-Ion battery operation.

Standard colors are white Ral 9016, satinized silver, anodized and chromed silver; any other color is available on request.

Any installation is available: wall or ceiling.

Plus

1

AZIONAMENTO A MOLLA DECELERATA

Slow è dotato di un sistema brevettato di decelerazione che permette di regolare la velocità di risalita della tenda.

La versione ø 36 mm è dotata di un dispositivo anti-shock brevettato che interviene quando la velocità di risalita della tenda diventa eccessiva (errata precarica della molla).

DECELERATED SPRING VERSION

Slow is equipped with a deceleration system so that the rolling up speed of the blind can be regulated.

In the version ø 36 the deceleration system is equipped with a patented anti-shock device that is triggered in the event of incorrect spring pre-loading.

2

AZIONAMENTO COMBINATO CATENELLA E MOLLA DECELERATA

Plus è la versione con comando brevettato a doppio azionamento che offre, allo stesso tempo, la praticità della catenella e la sofisticatezza della molla decelerata. La discesa della tenda avviene con l'azionamento della catenella, la molla decelerata permette risalita automatica. La velocità di risalita è regolata da un sistema di decelerazione che genera un movimento della tenda rallentato e costante.

COMBINED CHAIN - DECELERATED SPRING OPERATING

Plus is the patented twin operated system that offers the chain's comfort combined with a sophisticated decelerated spring. The blind is lowered by as a spring-operated clutch using the cord, it can stop in any position and is raised by touching the chain. The descent of the blind is controlled with the chain drive, the decelerated spring allows automatic rising.

The rising speed is controlled by a decelerated system that generates a slow and regular movement.

3

AZIONAMENTO A CATENA PER GRANDI DIMENSIONI

Sidewinder nella configurazione con azionamento a catena per grandi tende è dotato di un meccanismo demoltiplicato (rapporto 1:4) all'interno del tubo avvolgitore che riduce lo sforzo dell'azionamento e permette la realizzazione di tende per grandi superfici. **Sidewinder 8277** è un sistema per grandi tende (max. 400 x 440 cm) con azionamento demoltiplicato o diretto con molla di soccorso.

CHAIN OPERATING SYSTEM FOR LARGE BLINDS

*Sidewinder, in the chain operating version for heavy blinds, has a geared down drive (1:4 ratio); this device strongly reduces the effort to action heavy weight blinds. **Sidewinder 8277** is made up for large blinds (max. 400 x 440 cm). It is available geared down or spring assisted chain operating.*



Plus

AZIONAMENTO A MOTORE

Energy è il programma di tende a rullo con azionamento a motore.

Le versioni disponibili sono:

- **Energy 728-736-740** con azionamento a motore a batteria Li-Ion ricaricabile;
- **Energy 428** con azionamento a motore 24Vdc;
- **Energy 440-450-471-472-473** con azionamento a motore 230Vac.

L'azionamento, sia nella versione a tenda singola che in parallelo, può essere:

- Comando a pulsante;
- Via radio con telecomando e ricevitore R.F. integrato;
- Comando simultaneo pulsante e via radio con telecomando M2Net e ricevitore radio integrato 868/915 Mhz bidirezionale.

4

OPERATIONS

Energy is the range of motorized roller blinds by Mottura.

The available versions are as follows:

- **Energy 728-736-740** with Li-Ion rechargeable battery motor operating;
- **Energy 428** with 24Vdc motor operating;
- **Energy 440-450-471-472-473** with 230Vac motor operating.

The operations can be for single blinds and for multi linking solutions by:

- switch control;
- remote control and R.F. built in receiver;
- simultaneous switch and radio operating with M2Net remote control and integrated R.F. radio receiver 868/915 Mhz bidirectional.

GRANDI SUPERFICI

Energy è la gamma di tende a rullo outdoor e indoor adatte anche a grandi superfici vetrate. **Energy 473**, il top di gamma, è indicato fino a 48 m² per singolo sistema ed è la soluzione ottimale per i più ambiziosi progetti di protezione solare.

I cavi d'acciaio laterali ed il meccanismo d'arresto proteggono il sistema dalle oscillazioni causate dal vento.

5

MINIMUM LATERAL OVERALL

Energy is the range of outdoor and indoor roller blinds also suitable for large glazed surfaces. Energy 473, the top of the range, is recommended up to 48 m² with a single system.

Energy 473 is the optimal solution for the most ambitious sun protection projects.

The lateral steel cables and the stop mechanism protects the system from fluctuations caused by wind.



QuickFix



QuickFix è la soluzione Mottura per installare una tenda a rullo sia con azionamento a catenella che a molla decelerata, **direttamente sul serramento di una finestra o di una porta finestra senza forare il serramento in alluminio o pvc**, mantenendo intatte le caratteristiche di isolamento e la garanzia del serramento.

L'installazione di un prodotto QuickFix si effettua in modo semplice e veloce:

- Pulizia della superficie con alcool o prodotto specifico
- Applicazione del biadesivo invisibile
- Posizionamento della tenda
- Applicazione di una pressione di ca 1kg/cm con il pollice o un rullo pressore.

*QuickFix is the Mottura solution to install a chain or decelerated spring operating **directly on the frame of a window or door without drilling the aluminum or PVC surface** while keeping the insulation characteristics and in order to maintain the guarantee of the window or door.*

The installation of a QuickFix product is done quickly and easily:

- Surface cleaning with alcohol or specific cleaner
- Application of the double-sided adhesive
- Positioning of the blind
- Apply a pressure of about 1kg / cm with the thumb or a pressure roller.



Home automation

Rendi smart la tua casa controllando la tua tenda con l'interfaccia M2Net di Mottura S.p.a. M2Net è la piattaforma Mottura sviluppata per la gestione ed il controllo dei propri sistemi motorizzati che permette un continuo dialogo bidirezionale tra i dispositivi di comando ed i sistemi motorizzati.

Be smart controlling your curtain by M2Net interface. M2Net has been developed by Mottura to control its

REMOTE CONTROLS



own motorized systems. It allows a continuous two-way dialogue between the transmitter and R.F. receiver integrated in the motorized systems.



STATION

M2Net Station è il collegamento di Mottura con il web. Un prodotto "user-friendly", facile da installare e registrare.

M2Net Station is the link between Mottura and the web. A user-friendly product, easy to install and record.

La gamma / The range

SISTEMA SYSTEM	AZIONAMENTO OPERATION	L cm W cm max	A cm H cm max	TESSUTI FABRICS		INSTALLAZIONE INSTALLATION				
				FILTRANTI FILTERING	OSCURANTI BLACK-OUT	SOFFITTO CEILING	PARETE WALL	INCASSO FRAME	LUCERNARI SKYLIGHT	QUICKFIX
SLOW 1925	Molla Decelerata <i>Decelerated Spring</i>	160	260	●	●	●	●	●	●	●
SLOW 1928		260	400	●	●	●	●	●		
SIDEWINDER 8220	Catena <i>Chain Operating</i>	160	260	●	●	●	●	●		●
SIDEWINDER 8236		280	400	●	●	●	●	●		
SIDEWINDER 8243		300	400	●	●	●	●	●		
SIDEWINDER 8277		400	440	●	●	●	●	●		
PLUS 2139		Doppio azionamento <i>Soft Touch</i>	260	400	●	●	●	●	●	
HANDLE 1765	Arganello <i>Crank</i>	400	440	●	●	●	●	●		
ENERGY 428 24 VDC	Motorizzato <i>Motorized</i>	160	260	●	●	●	●	●		
ENERGY 440 230 VAC		300	400	●	●	●	●	●		
ENERGY 450 230 VAC		400	440	●	●	●	●	●		
ENERGY 471 230 VAC		400	440	●	●	●	●			
ENERGY 472 230 VAC		500	560	●	●	●	●			
ENERGY 473 230 VAC		600	800	●	●	●	●			
ENERGY 728	Motore a batteria Li-Ion <i>Battery motor</i>	160	260	●	●	●	●			
ENERGY 736		260	400	●	●	●	●			
ENERGY 740		300	400	●	●	●	●			

