

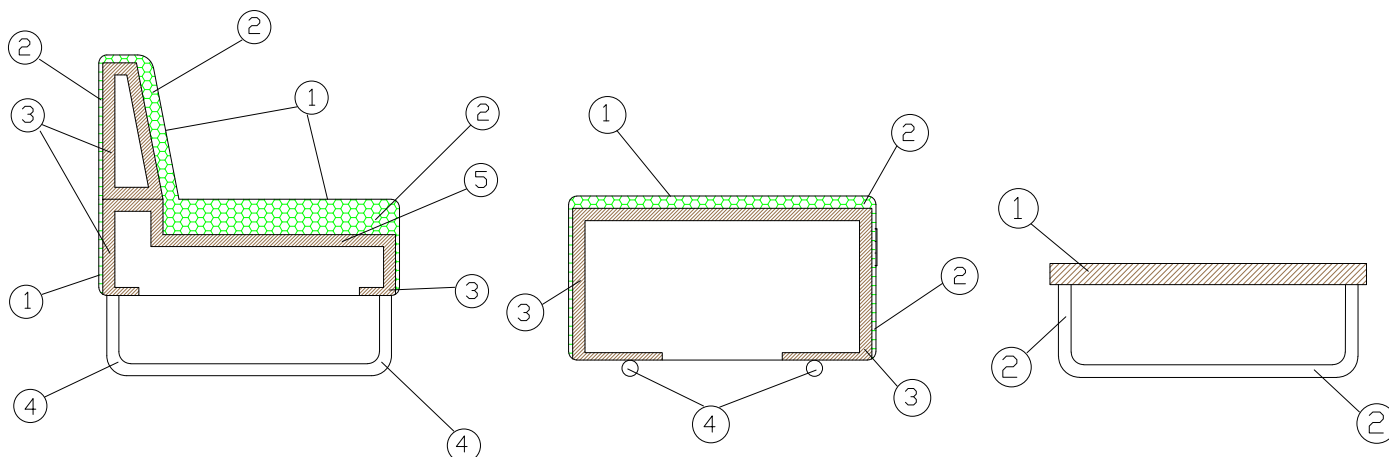

Eric è una collezione di sedute sollevata su gambe in metallo cromato o verniciato con colori Ral a scelta del committente, e dotata di un Hub free-standing con prese per ricaricare dispositivi mobili. Personalizzabile con lavorazioni sullo schienale.



ERIC POLTRONA-DIVANO

- 1 - fibra di dacron® 100 gr;
- 2 - poliuretano espanso indeformabile di diverse densità;
- 3 - telaio in multistrato di legno di abete;
- 4 - gambe tubolari in metallo cromato;
- 5 - struttura di rinforzo in multistrato di legno.

ERIC HUB

- 1 - fibra di dacron® 100 gr;
- 2 - poliuretano espanso indeformabile di diverse densità;
- 3 - telaio in multistrato di legno di abete;
- 4 - piede in metallo cromato.

ERIC TAVOLINO

- 1 - piano in multistrato laminato;
- 2 - gambe tubolari in metallo cromato.

DIMENSIONI

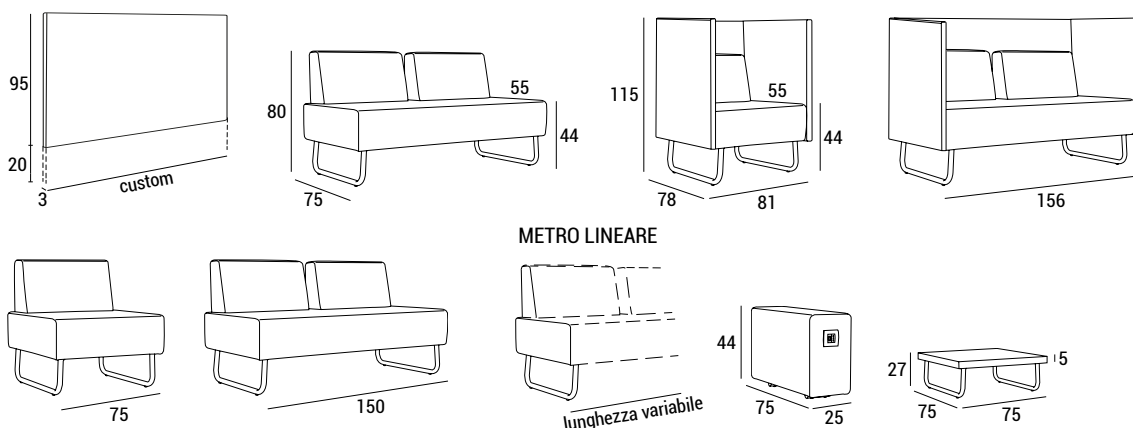



GAMBE E PIEDI

G 22 h 20 P 72 h 4



poltrona, divano e tavolino



hub

FINITURE GAMBA METALLO

Optional

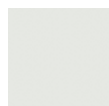

RAL 9003

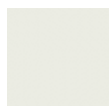

RAL 9016



RAL 9010



RAL 7035



RAL 9006



RAL 9005

RAL COLORE A SCELTA



FINITURE PIANO LAMINATO H 5 CM



BIANCO LARIX 990



VINTAGE 8019



ROV. NATURALE 1001



ROV. GRIGIO 7006



OLMO G. S. 7022

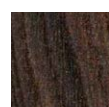

OLMO TINTO 8028



WENGÈ ARPA 4485 GHI

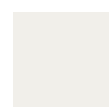

RAL 9016



RAL 9001



RAL 7035



RAL 7036



RAL 7015



RAL 9011

PRESE HUB

USB



La presa USB può essere inserita solo nell'elemento Hub.

Alimentazione 230 V. Tensione 5 Vd.c. per la sola ricarica di dispositivi elettronici fino a 1500 mA quali cellulari, smartphones, tablets e similari - alimentazione 230 Va.c. 1 modulo. Disponibile in bianco.

Kit di ricarica composto da 1 presa USB + 1 presa schuko.

SCHUKO



La presa schuko può essere inserita solo nell'elemento Hub.

Presa 2P+T 10/16A 250 Vac - bipasso interasse 19mm e 26mm -alveoli schermati. 1 modulo. Disponibile in Bianco.



FINITURE SCHIENALI

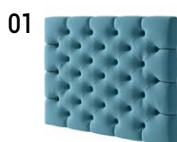

Capitonè



Mandorla con bottone

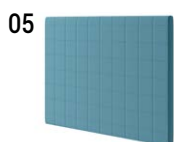

Scacchi cuciti



Scacchi trapuntati

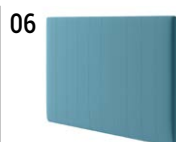

Fasce verticali cucite



Fasce verticali imbottite



Bottoni



INFORMAZIONI TECNICHE





			 tessuto mtl H 140 cm	 pelle m ²
ERIC PANNELLO METRO LINEARE	17	0.28	2.60	4.83
ERIC L 75 CON PANNELLI	32	0.72	11.40	21.20
ERIC L 150 CON PANNELLI	52	1.39	12.90	23.99
ERIC DIV. METRO LINEARE	38	0.60	3.50	6.51
ERIC L 75	28	0.45	3.00	5.58
ERIC L 150	48	0.90	4.50	8.37
ERIC HUB	15	0.08	1.80	4.50
ERIC TAVOLINO	12	0.15		

PHOTO GALLERY



Eric L 81 con pannelli



Eric L 156 con pannelli



Eric L 75



Eric L 150



Eric Hub



Eric Tavolino