

# Maryland

Extra Ordinary Kitchen

**Maryland**  
Extra Ordinary Kitchen

# Maryland

## Extra ordinary kitchen

Immagina un luogo dinamico,  
confortevole, con grande libertà  
di movimento.

Immagina uno spazio funzionale  
capace di rispondere ad ogni  
tua esigenza.

Immagina un luogo sicuro e sano,  
perché privo di elementi tossici  
o dannosi per l'uomo e l'ambiente.

Immagina un ambiente elegante,  
senza tempo, che si svincola dalle  
mode e dalle tendenze.

Immagina uno spazio che veste  
alla perfezione i tuoi sogni.

Stai pensando a Maryland.

Pag.			
06	Philosophy		
16	Material Surfaces		
26	Open Systems		
34	Kitchen Details		
42	<u>Maryland</u>	146	<u>Scacomatto</u>
42	<b>m.01</b>	146	<b>s.11</b>
52	<b>m.02</b>	160	<b>s.12</b>
62	<b>m.03</b>	176	<b>s.13</b>
72	<b>m.04</b>		
82	<b>m.05</b>		
94	<b>m.06</b>		
104	<b>m.07</b>		
114	<b>m.08</b>		
124	<b>m.09</b>		
134	<b>m.10</b>		
			194 Furnishing accessories
			206 Kitchen modularity
			220 Top
			236 Finishes



Riconosciamo l'importanza del design sostenibile, nel corso degli anni abbiamo adottato un approccio progettuale che pone attenzione alle risorse ambientali. In particolare: utilizziamo pannelli con minimo contenuto ed emissione di formaldeide, vernici prive di metalli pesanti e legni provenienti da foreste certificate.

**Maryland for the environment**

We recognise the importance of sustainable design: over the years we have developed an approach to design that considers environmental resources. In particular: we use panels with minimal content and emission of formaldehyde, paints free of heavy metals, and certified wood from sustainable forests.

**Maryland pour l'environnement**

Nous reconnaissons l'importance d'une conception durable, au fil des années, nous avons adopté une approche de conception qui accorde une attention aux ressources environnementales. En particulier: nous utilisons des panneaux à faible teneur et émission de formaldéhyde, des peintures exemptes de métaux lourds et du bois provenant de forêts certifiées.

# Maryland

## Bespoke solutions



La predisposizione a ricercare ed innovare ci ha portato ad espandere le soluzioni progettuali proponendo una modularità sempre più ampia, nonché finiture e complementi che permettono la massima personalizzazione dell'ambiente cucina.

**Bespoke solutions**

We carry out research and innovation to offer more solutions for greater modularity, as well as finishes and accessories for customising your kitchen environment.

**Solutions sur mesure**

Notre prédisposition à chercher et innover nous a conduit à étendre les solutions de design en proposant une modularité toujours plus large, ainsi que des finitions et accessoires qui permettent une personnalisation maximale de la cuisine.

# Maryland

## Qualità 100% made in Italy

La qualità è per noi un fattore chiave per rispondere alle esigenze di ogni singolo cliente. La qualità sta alla base di ogni lavorazione, in tutte le fasi del ciclo produttivo. Dalla selezione accurata dei materiali alla realizzazione, per offrirvi bellezza, prestazioni eccellenti e durata nel tempo.



#### **The quality of 100% Made in Italy**

We believe quality is a key factor in meeting the needs of each individual customer.

We prioritise quality during every process, and every stage of the production cycle - from careful selection of the materials to construction - to ensure beauty, excellent performance and durability.

#### **Qualité 100 % made in Italy**

Pour nous, la qualité est un facteur clé pour répondre aux besoins de chaque client.

La qualité est la base de chaque processus, à toutes les phases du cycle de production. De la sélection rigoureuse des matériaux à la construction, pour vous offrir beauté, excellentes performances et durabilité.



# Maryland

## Salubrità e atossicità dei materiali



Il benessere dell'uomo è al centro di ogni nostro progetto. Vogliamo che esso viva la quotidianità in tutta sicurezza, godendo a pieno di ogni esperienza. Ecco perché realizziamo le nostre cucine nel pieno rispetto dell'ambiente, assicurando la massima riduzione delle emissioni tossiche, l'eliminazione di composti dannosi o nocivi come la formaldeide mediante l'utilizzo di vernici ad acqua e pannelli ecologici.

**Healthiness and non-toxicity of the materials**

Human well-being is central to all our projects. We want you to live your daily life in complete safety, enjoying every experience to the full. That's why we make our kitchens in full respect of the environment, ensuring maximum reduction of toxic emissions, and the elimination of toxic or harmful compounds such as formaldehyde through the use of water-based paints and ecological panels.

**Salubrità e non-tossicità dei materiali**

Le bien-être de l'homme est au centre de tous nos projets. Nous voulons que chacun puisse vivre sa vie de tous les jours en toute sécurité, en profitant pleinement de chaque expérience. C'est pourquoi nous fabriquons nos cuisines dans le plein respect de l'environnement, en assurant une réduction maximale des émissions toxiques, l'élimination des composés dangereux ou nocifs tels que le formaldéhyde grâce à l'utilisation de peintures à base d'eau et des panneaux écologiques.



# Maryland

## 5-10 year guarantee



Affidabilità e Performance nel tempo sono i concetti su cui da anni progettiamo le nostre cucine. Ogni programma è concepito per durare nel tempo, grazie all'utilizzo di materiali di prima qualità e ad un design impermeabile al mutare delle tendenze. Proprio per questo offriamo una garanzia di 2 anni inclusa nel prezzo, e la possibilità della sua estensione fino a 5 o 10 anni. Un segno di riconoscimento verso chi sceglie la Qualità Spagnol Cucine.



### 5/10 year guarantee

Reliability and performance over time have been the hallmarks of our kitchens for many years. We design each programme to last over time, with top quality materials and a design impervious to changing trends. Precisely for this reason we offer a 2-year warranty included in the price, and the possibility of extending it up to 5 or 10 years.

A sign of recognition of those who choose Spagnol Cuine Quality.

### Garantie de 5/10 ans.

Fiabilité et performance dans le temps sont les concepts selon lesquels nous concevons nos cuisines depuis des années. Chaque programme est conçu pour durer dans le temps, grâce à l'utilisation de matériaux de première qualité et à un design imperméable aux tendances changeantes. C'est précisément pour cette raison que nous offrons une garantie de 2 ans incluse dans le prix et la possibilité de sa prolongation jusqu'à 5 ou 10 ans.

Un signe de reconnaissance envers ceux qui choisissent la qualité Spagnol Cucine.

# Maryland

## Sensations and high performance from material surfaces

Venature, trame e trasparenze: materiali da toccare, sentire, e vivere a pieno, per un progetto contemporaneo.

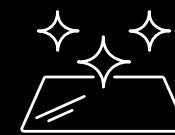

HYGIENIC SURFACES

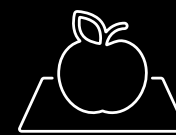

FOOD GRADE SURFACES

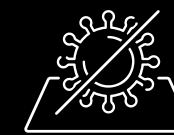

ANTIBACTERIAL SURFACES



SHOCK-RESISTANT SURFACES



FINGERPRINT RESISTANT SURFACES

**Vetri Laccati**  
— Riflessi d'autore.

Lucido o satinato, il vetro in cucina è un materiale di grande pulizia formale, ma anche resistente e durevole.

Lucido per una resa a specchio o satinato per una maggior piacevolezza al tatto e un effetto opaco anti-impronta.

**Lacquered Glass**  
— The perfect shine.

Glossy or satin glass in the kitchen is a material of great formal cleanliness, but also resistant and durable. Glossy for a mirror finish or satin for a greater pleasantness to the touch and an anti-fingerprint matt effect.

**Lacquered Glass**  
— Réflexes d'auteur.

Poli ou satiné, en cuisine, le verre est un matériau formel d'une grande propreté, mais aussi résistant et durable. Brillant pour une finition miroir ou satiné pour une plus grande douceur au toucher et un effet mat anti-traces de doigts.

**Fenix**  
— Superfici ad alta prestazione.

Fenix è un materiale ad alto contenuto tecnologico versatile e innovativo.

Dal colore intenso e profondo, ha una superficie morbida che regala piacevoli sensazioni tattili.

**Fenix**  
— High performance surfaces.  
Fenix is a high-tech material that is both versatile and innovative. With an intense and deep colour, it has a soft surface that is pleasant to the touch.

**Fenix**  
— Surfaces hautes performances.  
Fenix est un matériau de haute technologie polyvalent et innovant. Avec une couleur intense et profonde, il a une surface douce qui procure des sensations agréables au toucher.



## Legni — Venature d'eccellenza

Le cucine in legno creano atmosfere calde ed accoglienti, combinando il fascino senza tempo del legno al design più contemporaneo.

Essenze nobilitate o legni tinti: soluzioni che esaltano le venature e il colore del legno.

### Wood — Veins of excellence

A kitchen with wooden furnishings can have a warm and welcoming atmosphere, combining the timeless charm of wood with the most contemporary design. Ennobled essences or stained woods: solutions that enhance the grain and colour of wood.

### Bois — Veines d'excellence

Les cuisines en bois créent des ambiances chaleureuses et accueillantes, alliant le charme intemporel du bois au design le plus contemporain. Essences anoblies ou bois teintés: des solutions qui mettent en valeur les veines et la couleur du bois.





# Open Systems



**Gola Cava** — Il profilo della gola, in assenza della maniglia, fornisce a Maryland quella possibilità di apertura dell'anta in corrispondenza con la sua presa. Le volumetrie consentono una facilità di apertura dell'anta rendendo comodo il suo utilizzo. Il profilo è di forma cava, ed è disponibile in alluminio brillante, alluminio anodizzato nero spazzolato, e alluminio verniciato nelle assortite colorazioni nella gamma Spagnol Cucine.

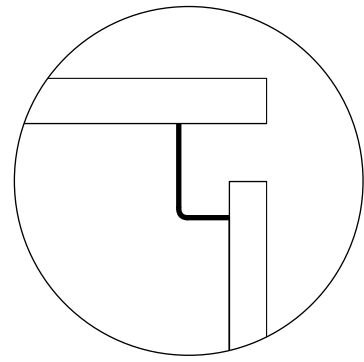

GOLA CAVA

**Groove** — The profile of the groove makes it possible to both grip and open the door. The design is such as to ensure ease of opening and comfort of use. The profile is hollow in shape, and is available in bright aluminium, Brushed Black Aluminum, and glossy varnished aluminium in various colours in the Spagnol Cucine range.

**Gorge** — Le profil de la gorge et l'absence de poignée donnent au Maryland la possibilité d'ouvrir la porte en correspondance avec la poignée. Les volumes permettent une ouverture facile de la porte rendant son utilisation confortable. Le profil est de forme creuse et est disponible en aluminium brillant, en Aluminium noir brossé et en aluminium vernis brillant dans la gamme de couleurs proposée par Spagnol Cucine.

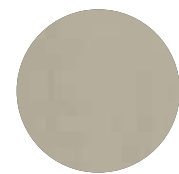

**Titanio**  
Titanium  
Titane



**Alluminio Nero Spazzolato**  
Brushed Black Aluminum  
Aluminium noir brossé



**Alluminio Brillante**  
Brilliant Aluminium  
Aluminium Brillant

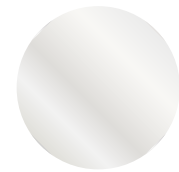

**Verniciato**  
Varnished  
Verni



**Maniglie** — La proposta Maryland è ampia, dal taglio a 30° a vari profili orizzontali o verticali che grazie alla loro versatilità, consentono di soddisfare qualsiasi esigenza estetica e funzionale. In alternativa o in abbinamento alle maniglie è possibile scegliere il Push-pull. Un sistema pratico e pulito basato su un pistone da premere, posto in cima al fusto retrostante all'anta.

**Handles** — Maryland offers a broad range of these, with a 30° angle and various horizontal or vertical profiles which, thanks to their versatility, can meet any aesthetic and functional need. Alternatively, or in combination with the handles, you can choose the Push-pull. It is a practical and simple system which involves pressing a piston on top of the stem behind the door.

**Poignées** — La proposition Maryland est large, avec une coupe à 30° avec différents profils horizontaux ou verticaux qui, grâce à leur polyvalence, permettent de satisfaire tout besoin esthétique et fonctionnel. À la place ou en combinaison avec les poignées, vous pouvez choisir le système push-pull. Un système pratique et propre fonctionnant grâce à un piston à presser, placé sur le dessus de la tige derrière la porte.

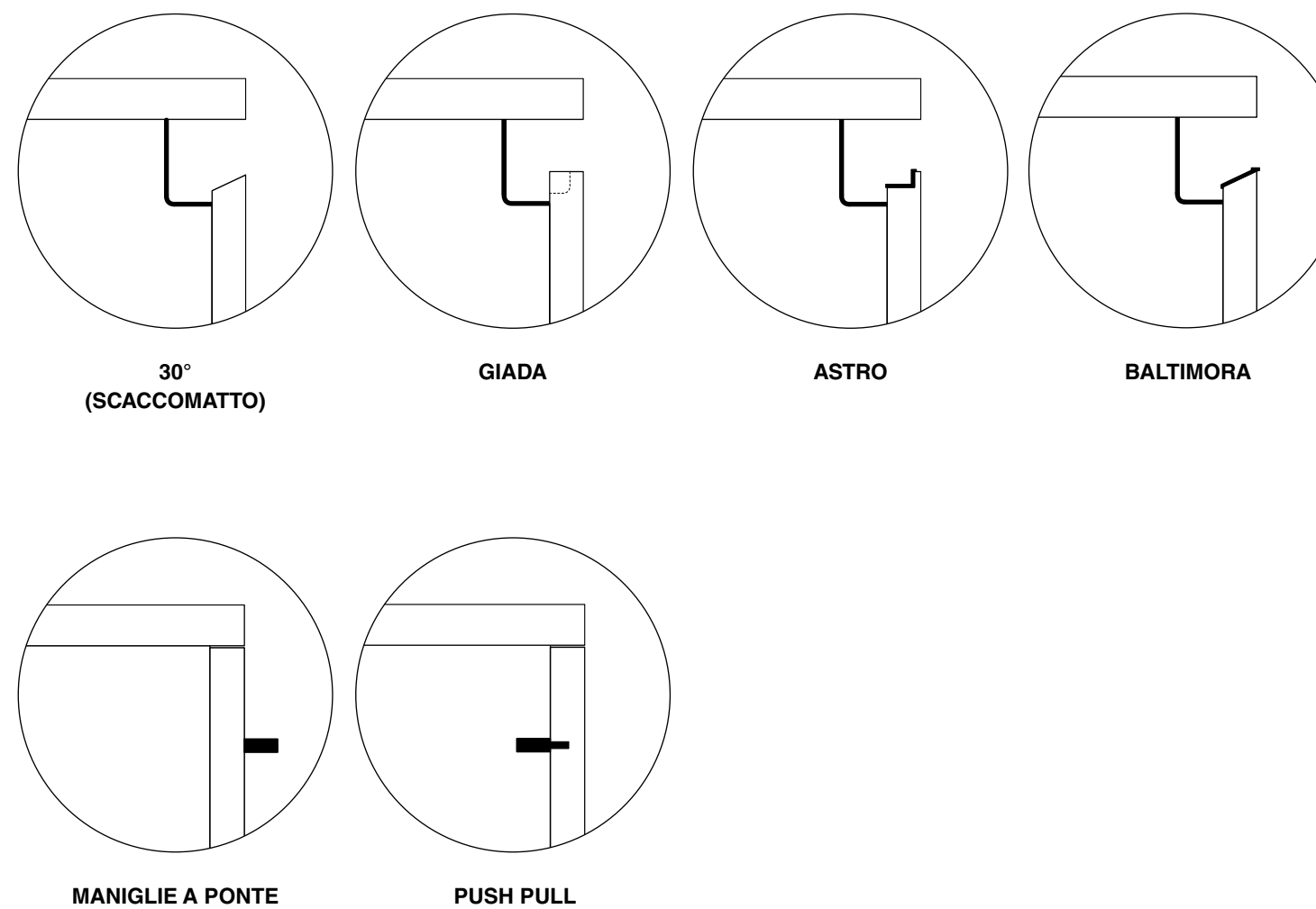



Le maniglie sono disponibili nelle tinte:  
Brill o in tinta laccata opaco.

The handles are available in these colours:  
Brill or Matt lacquered colour.

Les poignées sont disponibles dans les  
couleurs: Brillant ou de couleur laquée mate.







## Kitchen Details





## Colonne e Pensili in vetro "Luxury" — trasparenze raffinate

Anta in alluminio antracite con maniglia integrata e vetro fumè, ripiani in vetro, schiena personalizzabile. Su richiesta è inoltre possibile installare una lampada a LED dotata di sensore incorporato per l'accensione automatica ad ogni apertura dell'anta.

### "Luxury" glass columns and wall cabinets — Refined transparent effects

Anthracite aluminium door with integrated handle and smoked glass, glass shelves, customisable back. On request it is also possible to install an LED lamp with built-in sensor which turns on the lamp every time the door is opened.

### Colonnes et éléments hauts en verre "Luxury" — Transparence raffinée

Porte en aluminium anthracite avec poignée intégrée et verre fumé, étagères en verre, fond personnalisable. Sur demande, il est également possible d'installer une lampe LED avec capteur intégré pour l'allumage automatique à chaque ouverture de la porte.





## Pareti attrezzate "Modular" — Personalizza il tuo spazio

Strutture in alluminio antracite leggere e funzionali con schiena personalizzabile.

Declinabili nelle versioni a colonna da terra o sospesa, e nella versione sottopensile che permette di ottimizzare gli spazi della cucina sfruttando lo spazio tra top e pensili. Una semplicità che assicura un'eccezionale versatilità.

### "Modular" equipped walls — Customise your space

Lightweight and functional anthracite aluminium structures with customisable back.

Available in floor or wall-mounted column versions, and in an under-cabinet version that optimises the use of space between tops and wall units in the kitchen. A simplicity that ensures exceptional versatility.

### Murs équipés "Modular"

#### — Personnalisez votre espace

Structures en aluminium anthracite léger et fonctionnel avec fond personnalisable.

Disponible en version colonne au sol ou suspendue, et en version sous meuble qui vous permet d'optimiser les espaces de la cuisine en exploitant l'espace entre les meubles et les éléments hauts. Une simplicité qui assure une polyvalence exceptionnelle.







## Tatep — Finiture di pregio

Maryland ha sviluppato diverse soluzioni per dare vita ad una cucina elegante e raffinata, dall'estetica rigorosa ed essenziale.

Una di queste è il Tatep: un elemento di finitura angolare, valida alternativa nel caso in cui non si voglia terminare la composizione con un semplice pannello di finitura.

### **Tatep**

#### **— Luxury finishes**

Maryland has developed various solutions for elegant and sophisticated kitchens with a sleek and essential look. One of these is the Tatep: a corner finishing element, perfect when you prefer not to have a simple finishing panel.

### **Tatep**

#### **— Finitions haute qualité**

Maryland a développé plusieurs solutions pour donner vie à une cuisine élégante et raffinée à l'esthétique rigoureuse et essentielle. L'une d'entre elles est le Tatep: un élément de finition d'angle, une alternative au cas où que vous ne voudriez pas finir votre composition avec un simple panneau de finition.



**Volumi imponenti e linee compositive decise.**

**Una soluzione dalla forte valenza architettonica pensata per grandi spazi.**

**Le aree funzionali della cucina sono inglobate in strutture monolitiche. Le colonne, qui proposte con altezza massima grazie all'utilizzo di sopracolonne, diventano dei veri e propri volumi strutturali capaci di delineare gli ambienti circostanti.**

**EN.** Big volumes and sharp lines. A solution with strong architectural value for big spaces. The functional areas of the kitchen are incorporated in monolithic structures. The tall units, here at their maximum height thanks to the use of surmounting units, become real structural units able to delineate the surrounding rooms.

**FR.** Cuisine dotée de volumes imposants et de lignes épurées marquées. Une composition d'une grande beauté architecturale, conçue pour les espaces importants. Les zones fonctionnelles de la cuisine sont englobées dans des structures monolithiques. Les colonnes, ici dotées d'un élément supérieur et donc proposées dans leur hauteur maximum, deviennent de véritables volumes structuraux capables de délimiter les espaces environnants.

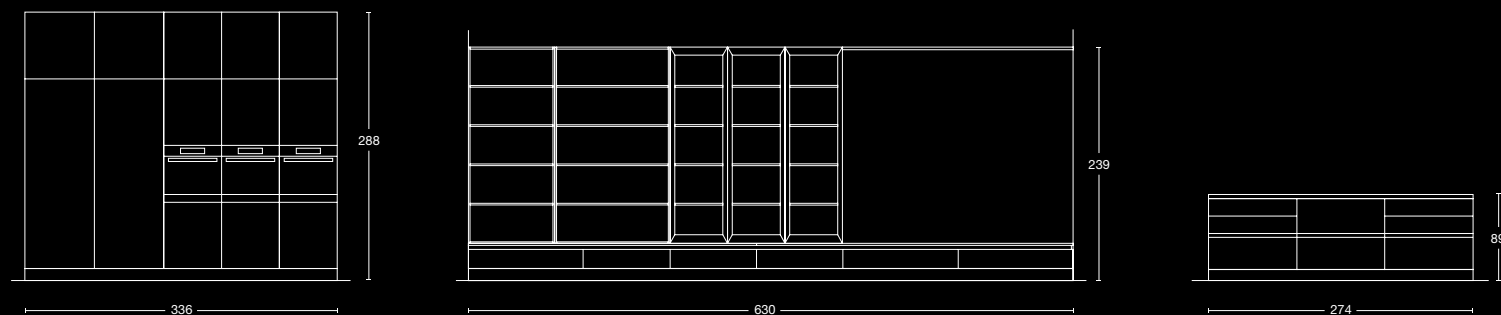

# m.01

Laccato UV Easylak Gloss Grigio Antracite / Grigio Pietra  
Decorativo Noce Canaletto  
Anta Vetro fumè  
Top in Gres Sahara Noir Honed









Isola in finitura Laccato UV Easylak Gloss Antracite, Top in Gres Sahara Noir Honed.

Island with Anthracite UV lacquer Easylak gloss finish, Sahara Noir Honed stoneware top.

Îlot en finition laquée Easylak UV Gloss anthracite, Plateau en grès Sahara Noir Honed.





- 1 → Struttura a giorno in Noce Canaletto.
- 2 → Colonne vetrina con ante battenti in alluminio antracite e vetro fumè.
- 3 → Basi a terra in Laccato UV Easylak Gloss Grigio Antracite.
- 4 → Colonne in Laccato UV Easylak Grigio Pietra.
- 5 → Penisola in Laccato UV Easylak Grigio Antracite, Top in Gres Sahara Noir Honed.
- 6 → Piano Snack in Fenix Bianco Kos.

- 1 → Open structure in Noce Canaletto.
- 2 → Showcase columns with hinged doors in anthracite aluminium and smoked glass.
- 3 → Floor bases with Grigio Antracite Easylak Gloss UV lacquer.
- 4 → Columns with Grigio Pietra Easylak UV Lacquer.
- 5 → Peninsula with Grigio Antracite Easylak UV Lacquer, Sahara Noir Honed Stoneware Top.
- 6 → Bianco Kos Fenix Snack Bar.

- 1 → Structure ouverte en Noce Canaletto.
- 2 → Colonnes vitrine avec portes battantes en aluminium anthracite et verre fumé.
- 3 → Bases au sol en laqué UV Easylak Gloss Grigio Antracite.
- 4 → Colonnes en laqué UV Easylak Grigio Pietra.
- 5 → Îlot en laqué UV Easylak Grigio antracite, plateau en grès Sahara Noir Honed.
- 6 → Plan snack en Fenix Bianco Kos.

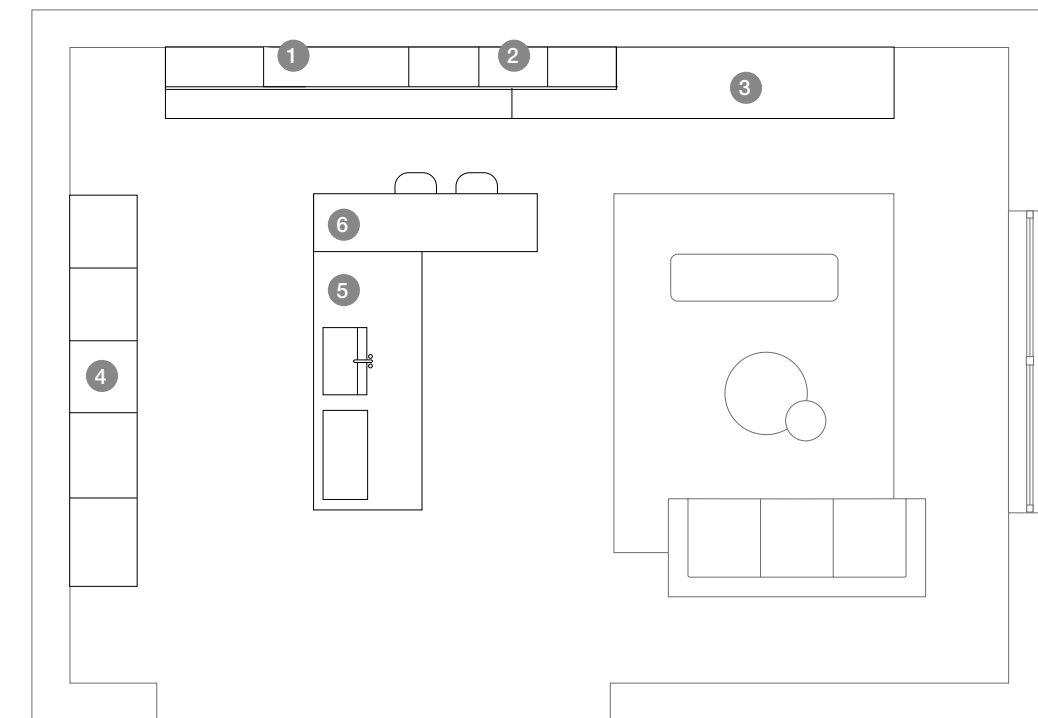

**Con la sua eleganza e il suo rigore, il Grigio Seta è il vero protagonista di questa composizione. La raffinatezza della finitura lucida si fonde con le vene del top in Gres. Ne risulta uno spazio attuale, luminoso e perfettamente organizzato, grazie alle colonne attrezzate e al sistema di elementi a giorno.**

**EN.** With its elegance and rigour, the Grigio Seta finish is the real protagonist in this composition. The refinement of glossy white finish blends perfectly with the grain of the stoneware top. The result is a modern space that is bright and perfectly organized thanks to the equipped tall units and the open element system.

**FR.** Avec son élégance et sa rigueur, le Grigio Seta est la véritable star cette composition. Le raffinement de la finition brillante se confond avec les veines du plateau en grès. Le résultat est un espace contemporain, lumineux et parfaitement organisé, grâce aux colonnes équipées et au système d'éléments ouverts.

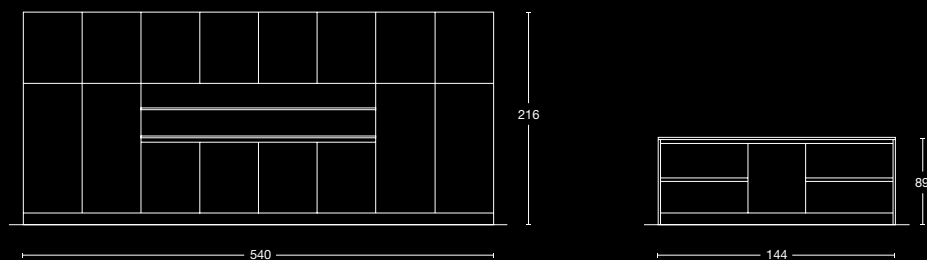

# m.02

Laccato UV Easylak Gloss Grigio Seta  
Decorativo Noce Lloyd  
Top in Gres Ombra di Caravaggio Honed











Colonne in finitura Laccato UV Easylak Grigio Seta, nicchia a giorno con schienale in Decorativo Noce Lloyd.

Columns with Easylak Grigio Seta UV lacquer finish, open niche with Noce Lloyd Decorative back.

Colonnes en finition UV Easylak Grigio Seta, niche ouverte avec fond en Noce Lloyd Décoratif.





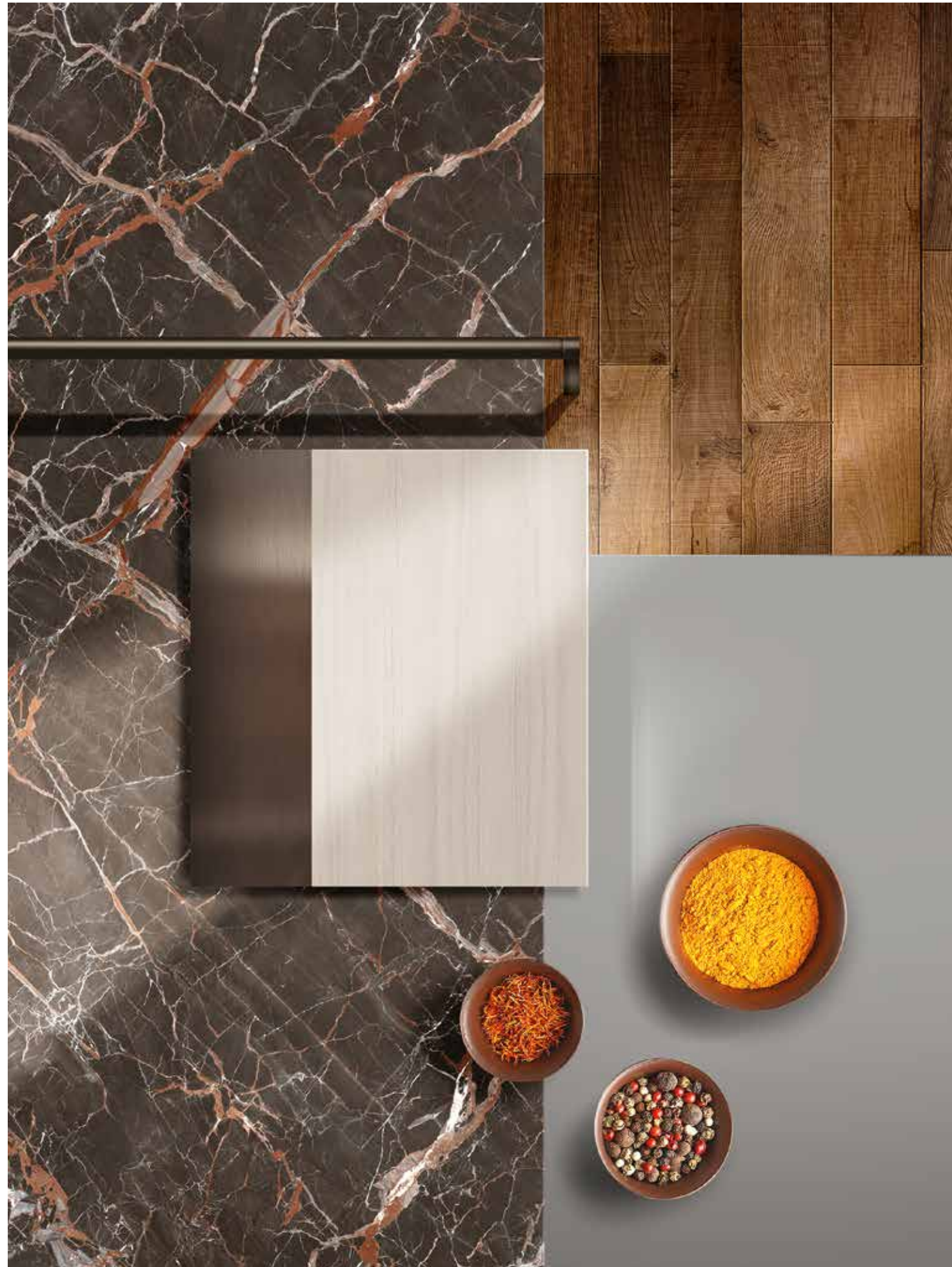

**1** → Colonne in Laccato UV Easylak Gloss Grigio Seta, schienale in Decorativo Noce Lloyd.  
**2** → Penisola in Laccato UV Easylak Gloss Grigio Seta, Top in Gres Ombrà di Caravaggio Honed.

**1** → Columns with Easylak Gloss Grigio Seta UV lacquer, Noce Lloyd Decorative back.  
**2** → Peninsula with Easylak Gloss Grigio Seta UV lacquer, Ombrà di Caravaggio Honed Stoneware Top.

**1** → Colonnes en laqué UV Easylak brillant Grigio Seta, fond en Noce Lloyd décoratif.  
**2** → Îlot en laqué UV Easylak brillant Grigio Seta, plateau en grès Ombrà di Caravaggio Honed.

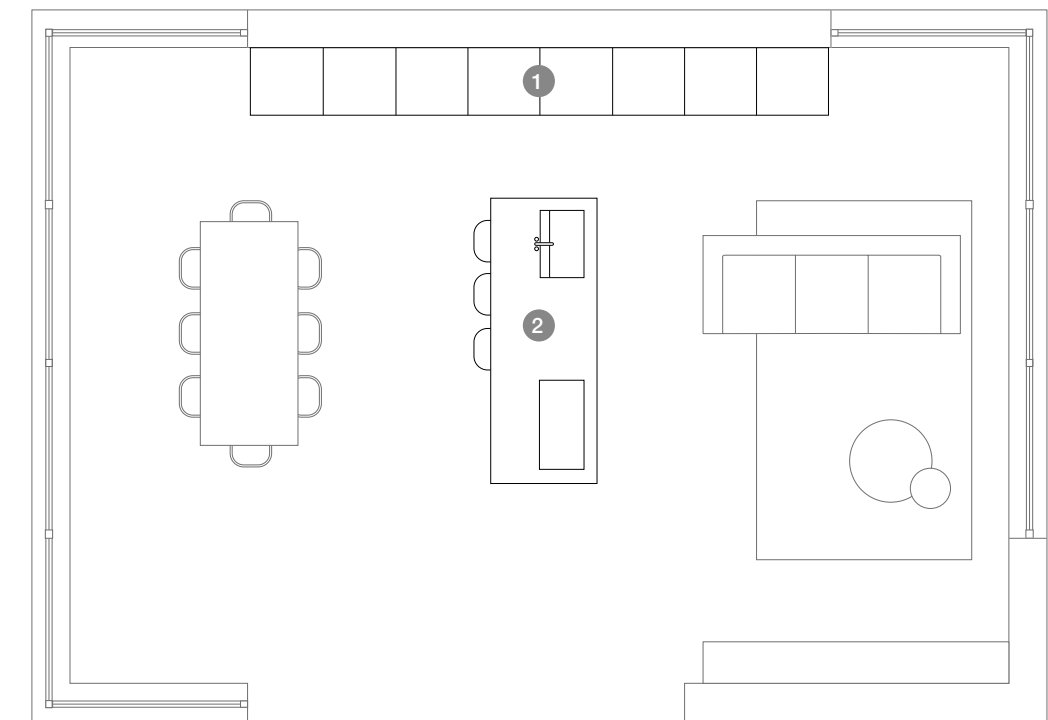

**Una disposizione lineare perfetta per un open space in cui la cucina diviene la protagonista di un ambiente equilibrato e in continuo dialogo con la zona pranzo ed il soggiorno.**

**EN.** A linear set-up perfect for an open space in which the kitchen becomes the protagonist of a balanced environment and one in continuous dialogue with the dining area and the living room.

**FR.** Un arrangement linéaire parfait pour un espace ouvert où la cuisine devient le point central d'un environnement équilibré et en dialogue continu avec la salle à manger et le salon.

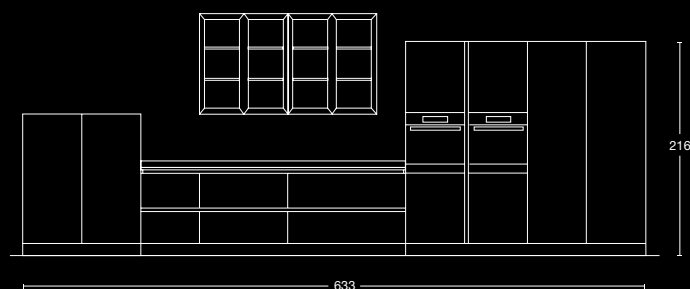

# m.03

Fenix Rosso Askja  
Laccato UV Easylak Matt Grigio Pietra  
Decorativo Noce Canaletto  
Anta Vetro fumè  
Top Bianco opaco













Pensili con profilo in alluminio antracite e vetro fumé. Maniglia integrata.

Wall units with anthracite aluminium profile and smoked glass. Built-in handle.

Éléments hauts avec profil en aluminium antracite et verre fumé. Poignée intégrée.



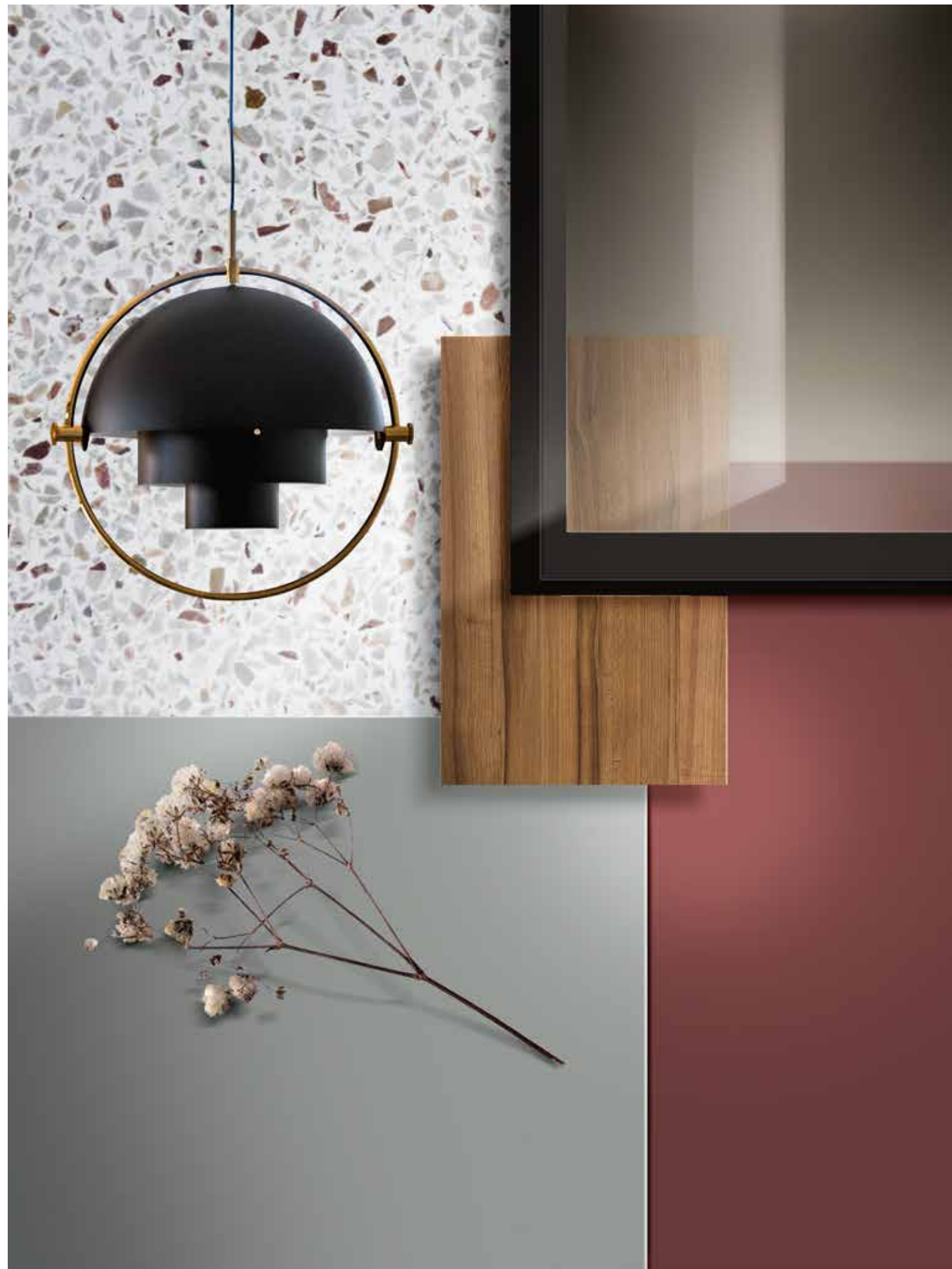

- 1 → Pannelli in Noce Canaletto.
- 2 → Colonne in Fenix Rosso Askja.
- 3 → Basi a terra in Fenix Rosso Askja, Top in Quarzo Bianco Assoluto.
- 4 → Pensili vetrina con ante battenti in alluminio antracite e vetro fumè.
- 5 → Colonne in Laccato UV Easylak Matt Grigio Pietra.

- 1 → Panels in Noce Canaletto.
- 2 → Columns in Fenix Rosso Askja.
- 3 → Floor base in Fenix Rosso Askja, Bianco Assoluto Quartz Top.
- 4 → Display cabinets with hinged doors in anthracite aluminium and smoked glass.
- 5 → Columns with Easylak Matt Grigio Pietra UV lacquer.

- 1 → Panneaux en Noce Canaletto.
- 2 → Colonne en Fenix Rosso Askja.
- 3 → Base au sol en Fenix Rosso Askja, plateau en Quartz Bianco Assoluto.
- 4 → Vitrines à portes battantes en aluminium anthracite et verre fumé.
- 5 → Colonne en laqué UV Easylak mat Grigio Pietra.

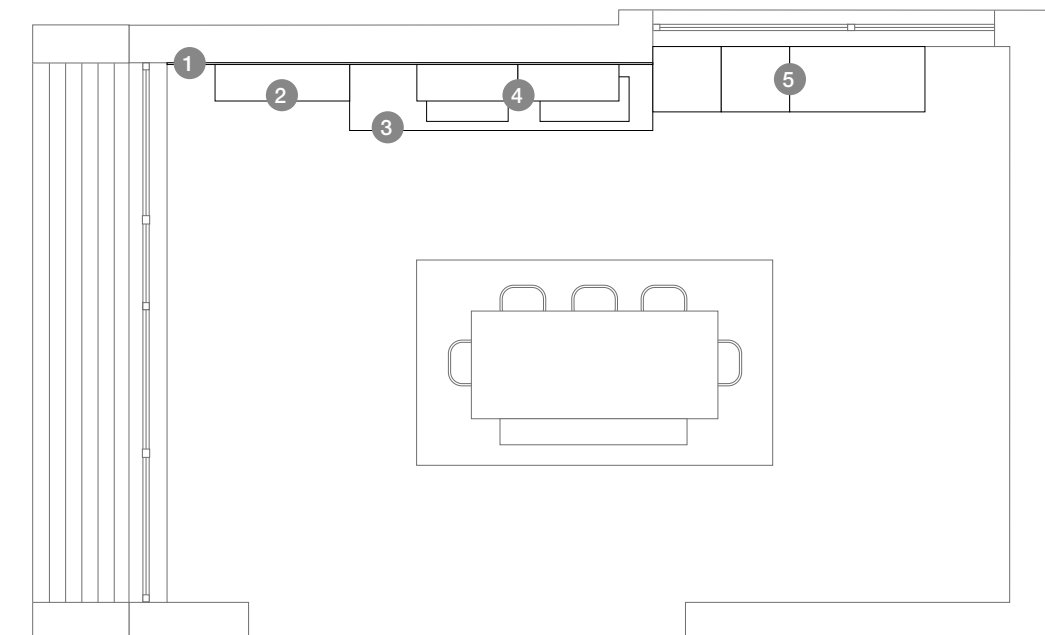

**Versatile, pratica e dinamica.**

**Questa composizione è la soluzione ideale per chi identifica la cucina come uno spazio aperto al living, globale, da vivere a pieno in ogni momento della giornata.**

**EN.** Versatile, practical and dynamic.

This composition is the ideal solution for anyone who identifies the kitchen as an all-round space open to living, to be fully used throughout the day.

**FR.** Polyvalent, pratique et dynamique.

Cette composition est la solution idéale pour ceux qui identifient la cuisine comme un espace ouvert sur l'espace de vie, un environnement global à vivre pleinement à tout moment de la journée.



# m.04

Laccato UV Easyilak Matt Antracite  
Decorativo Noce Lloyd  
Top Pietra Acid Iron Opaco













Penisola con Top Pietra Acid Iron Opaco,  
elementi a giorno in in Noce Lloyd.

Peninsula with top in Matt Acid Iron Stone,  
open elements in Noce Lloyd.

Îlot avec plateau pierre Acid Iron mate,  
éléments ouverts en Noce Lloyd.



- 1 → Struttura a giorno in Noce Lloyd.
- 2 → Pensili in Laccato UV Easylak Matt Antracite.
- 3 → Penisola in Laccato UV Easylak Matt Antracite, Top in Pietra Acid Iron Opaco.

- 1 → Open structure in Noce Lloyd.
- 2 → Wall units with Antracite Easylak Matt UV Lacquer.
- 3 → Peninsula with Easylak Matt Anthracite UV lacquer, Top in Matt Acid Iron Stone.

- 1 → Structure ouverte en Noce Lloyd.
- 2 → Éléments hauts en laqué UV Easylak Matt Antracite.
- 3 → Îlot en laqué UV Easylak Matt Grigio Antracite, plateau en pierre Acid Iron.

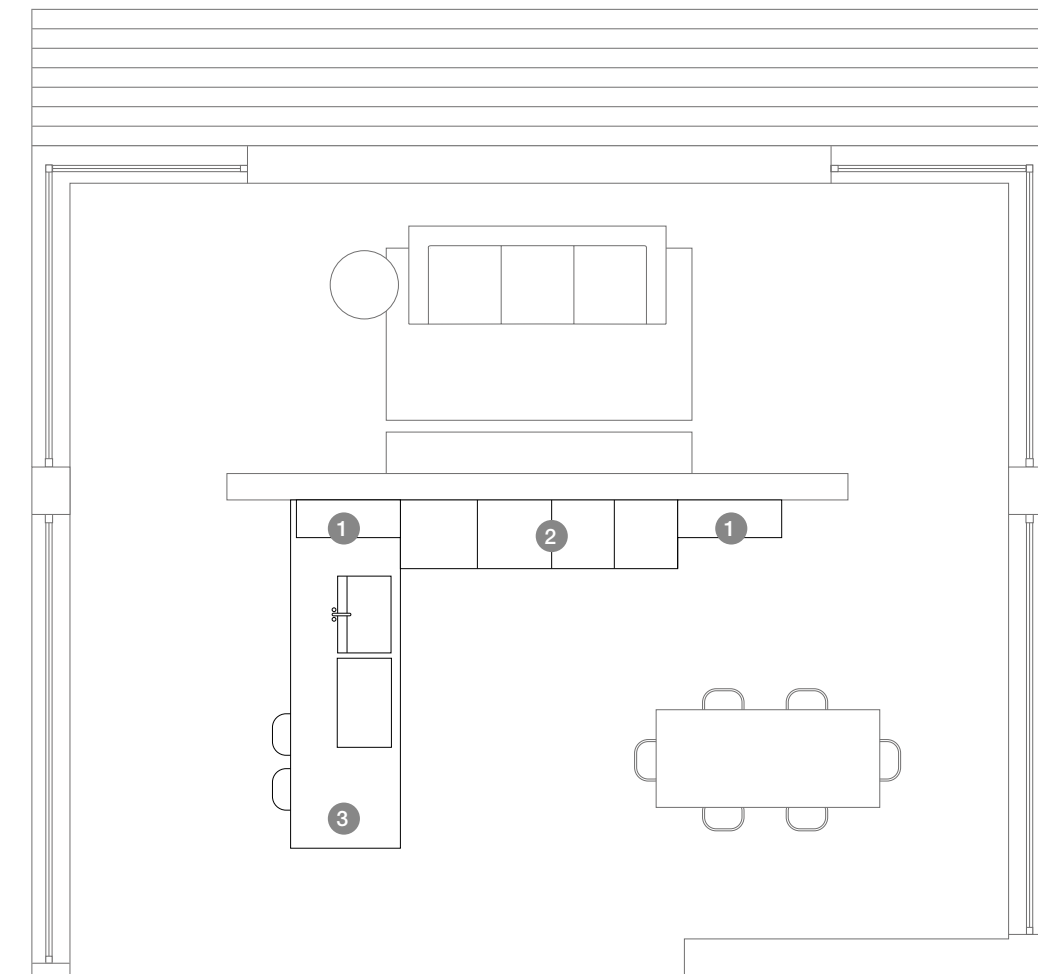



**Basi, mensole, colonne attrezzate e pensili vetrina concorrono ad ottenere uno spazio perfettamente organizzato, per vivere meglio la quotidianità di ogni giorno. L'utilizzo della penisola permette di conservare il senso di apertura tipico del loft e garantisce l'interazione con il living. Una perfetta sintesi tra bellezza e praticità.**

**EN.** Bases, shelves, equipped tall units and glass wall units all fit together to obtain a perfectly organized space, to live daily life more easily. The use of the peninsula with open units preserves the sense of openness typical of a loft and guarantees interaction with the living room. The perfect mixture between beauty and practicality.

**FR.** Bases, étagères, colonnes équipées et vitrines s'associent pour obtenir un espace parfaitement organisé, pour mieux profiter du quotidien. L'utilisation de l'îlot permet de maintenir le sens de l'ouverture typique du loft et garantit l'interaction avec le salon. Une synthèse parfaite entre beauté et praticité.

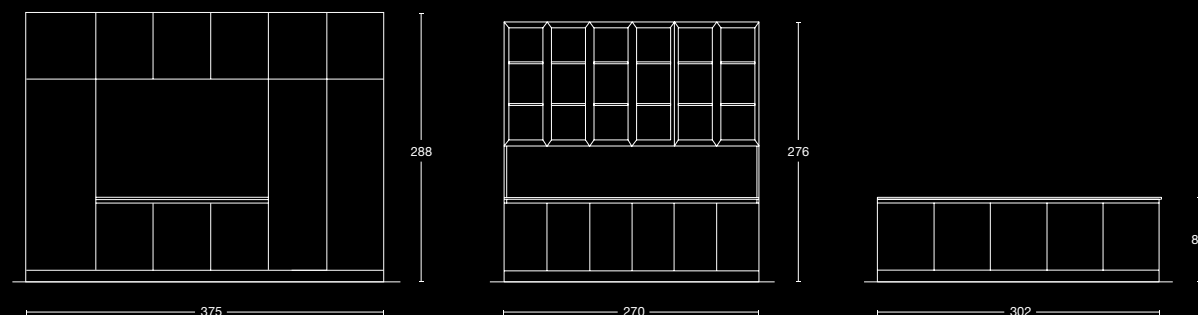

# m.05

Laccato UV Easylak Gloss Bianco  
 HPL Grey Stone  
 Decorativo Noce Lloyd  
 Anta Vetro fumè  
 Top Calacatta Gold Honed









Pensili vetrina con ante battenti.  
Profilo in alluminio antracite opaco,  
anta e fianchi in vetro fumè.  
Struttura sottopensile in alluminio antracite  
e schienale in Noce Lloyd.

Showcase wall units with hinged doors.  
Profile in matt anthracite aluminium,  
door and sides in smoked glass.  
Under-cabinet structure in anthracite  
aluminium and back in Noce Lloyd.

Vitrines avec portes battantes.  
Profil en aluminium antracite mat,  
porte et côtés en verre fumé.  
Structure sous meuble en aluminium  
antracite et fond en Noce Lloyd.







Colonne in finitura Laccato UV Easylak Gloss Bianco, nicchia a giorno con schienale in Decorativo Noce Lloyd.

Columns with Easylak Bianco Gloss UV lacquer finish, open niche with Lloyd Walnut Decorative back.

Colonnes en laqué UV Easylak Gloss bianco, niche ouverte avec fond en noyer Lloyd décoratif.





**1** → Colonne in Laccato UV Easylak Gloss Bianco, schinale in Decorativo Noce Lloyd.  
**2** → Penisola in Laccato UV Easylak Gloss Bianco e HPL Grey Stone, Top in Gres Calacatta Gold Honed.  
**3** → Basi a terra in HPL Grey Stone.  
 Pensili vetrina con ante battenti in alluminio Antracite e vetro fumè.  
 Struttura sottopensile in alluminio antracite e schinale in Decorativo Noce Lloyd.

**1** → Columns with Bianco Easylak Gloss UV lacquer, Noce Lloyd Decorative back panel.  
**2** → Peninsula with Bianco Easylak Gloss UV lacquer and HPL Grey Stone, Calacatta Gold Honed Stoneware Top.  
**3** → Floor bases with HPL Grey Stone.  
 Display cabinets with hinged doors in Anthracite aluminium and smoked glass.  
 Under-cabinet structure in anthracite aluminium and Noce Lloyd Decorative back panel.

**1** → Colonne en laqué UV Easylak Gloss Bianco, fond en Noce Lloyd décoratif.  
**2** → Îlot en laqué UV Easylak Gloss Bianco et HPL Grey Stone, plateau en grès Calacatta Gold Honed.  
**3** → Base au sol en HPL Grey Stone.  
 Vitrines à portes battantes en aluminium Anthracite et verre fumé. Structure sous meuble en aluminium anthracite et fond en Noce Lloyd décoratif.

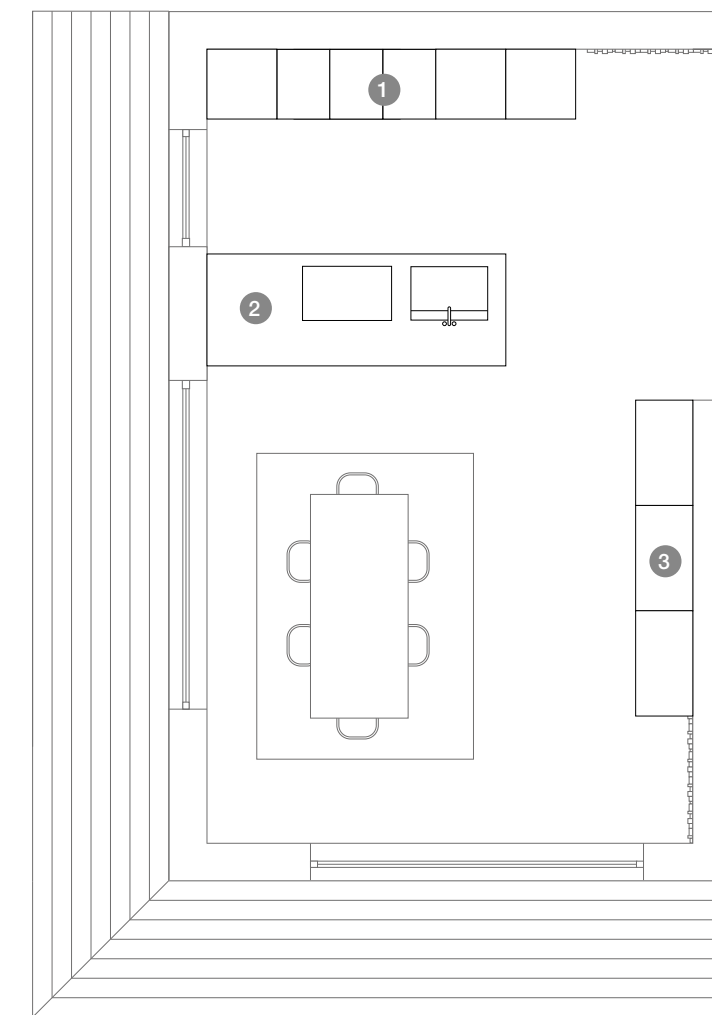



**Pura luminosità e accostamenti cromatici decisi.  
L'accostamento di basi colonne e vani a giorno  
di grandi altezze disegnano spazi operativi inediti,  
dove la cucina si integra con la zona living.**

**EN.** Pure brightness and strong colour combinations.  
The juxtaposition of base, tall and open units of great  
height gives an unusual working space, with the  
kitchen an integral part of the living area.

**FR.** Pure luminosité et combinaisons de tons fortes.  
La combinaison de modules de base des colonnes  
et des compartiments ouverts de grande hauteur  
crée des espaces inédits, où la cuisine s'intègre à  
l'espace de vie.

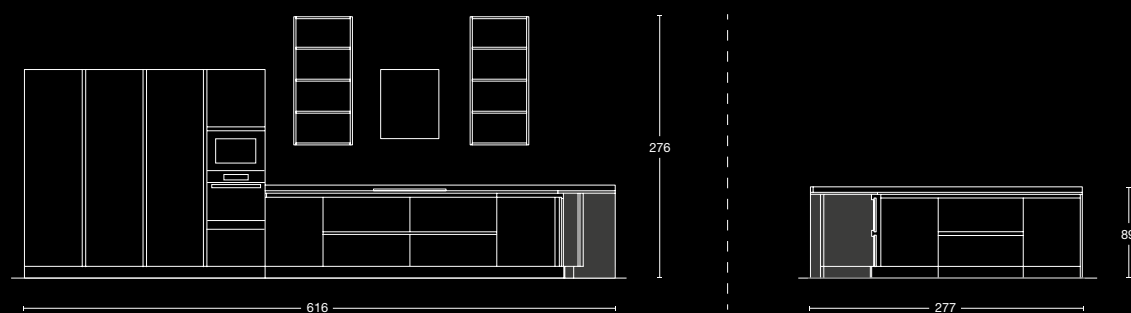

# m.06

Laccato UV Easylak Matt Bianco  
Fenix Nero Ingo  
Decorativo Noce Lloyd  
Top Calacatta Gold Honed











Pensile a giorno con struttura in alluminio Nero opaco e piani Laccati UV EasyLak Matt Bianco.

Open wall unit with Matt Black aluminium structure and Bianco EasyLak UV lacquer Matt tops.

Élément mural ouvert avec structure en aluminium noir mat et plan en laqué UV EasyLak Matt Bianco.





- 1 → Pannelli in Noce Lloyd.
- 2 → Colonne in Fenix Nero Ingo.
- 3 → Basi a terra in Laccato UV Easylak Matt Bianco, Top in Gres Calacatta Gold Honed.
- 4 → Pensili a giorno con struttura nero opaco e ripiani in Laccati UV Easylak Matt Bianco.

- 1 → Panels in Noce Lloyd.
- 2 → Columns in Fenix Nero Ingo.
- 3 → Floor bases with Easylak Matt Bianco UV lacquer, Calacatta Gold Honed Stoneware Top.
- 4 → Open wall units with matt black structure and shelves with Matt Bianco Easylak UV lacquer.

- 1 → Panneaux en Noce Lloyd.
- 2 → Colonnes en Fenix Nero Ingo.
- 3 → Base au sol en laqué UV Easylak Matt Bianco, plateau en grès Calacatta Gold Honed.
- 4 → Éléments hauts ouverts avec structure noire mate et étagères en laqué UV Easylak Matt Bianco.

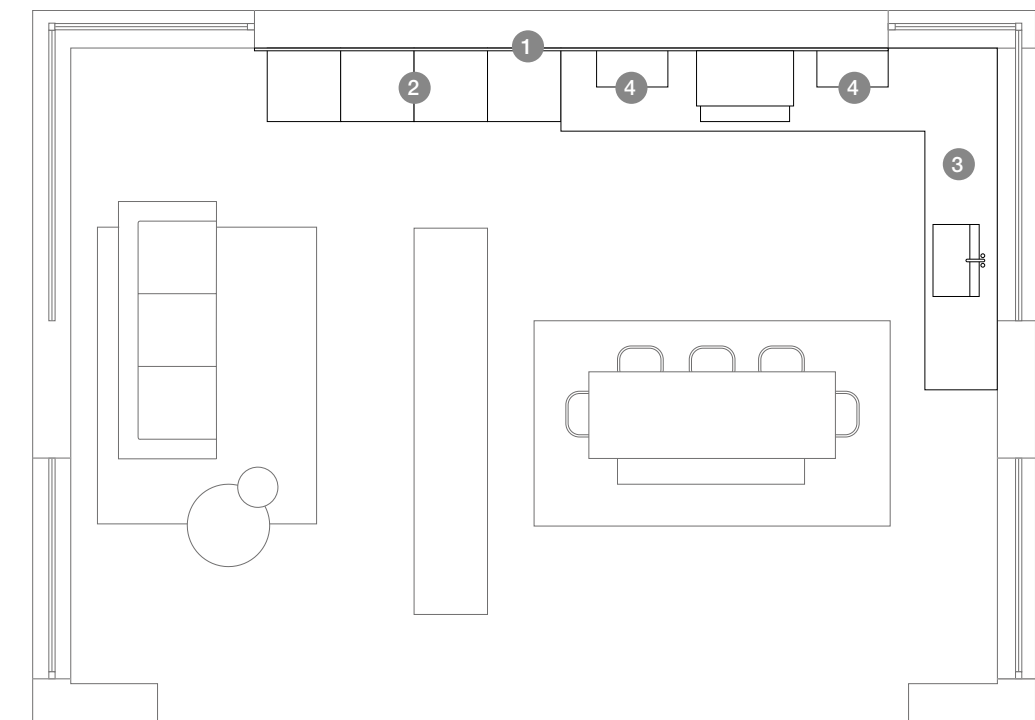

**Libertà compositiva, funzionalità, e grande capienza:  
Maryland risponde all'esigenza più funzionale di  
contenimento. Elementi a giorno mensole,  
pensili chiusi, basi e colonne attrezzate, concorrono ad  
ottenere uno spazio perfettamente organizzato,  
per vivere meglio la quotidianità di ogni giorno.  
Una perfetta sintesi tra bellezza e praticità.**

**EN.** Freedom in composition, function and capacity:  
Maryland is the answer to anybody's need for functional  
storage. Open elements, shelves, closed wall units,  
bases and equipped tall units all fit together to obtain a  
perfectly organized space, to live daily life more easily.  
The perfect mixture between beauty and practicality.

**FR.** Liberté de composition, de fonctionnalité et grande  
capacité: le Maryland répond au besoin de rangement  
le plus fonctionnel. Étagères ouvertes, éléments  
hauts fermés, les bases et les colonnes équipées  
se combinent pour obtenir un espace parfaitement  
organisé, pour mieux vivre au quotidien.  
Une synthèse parfaite entre beauté et praticité.

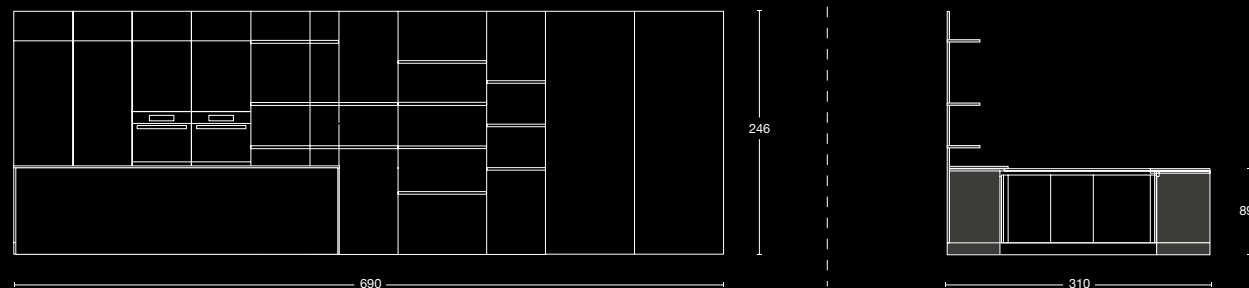

# m.07

Fenix Verde Brac  
Decorativo Noce Lloyd  
Top Gres Fior di Bosco











Pareti attrezzare con schiene in Noce Lloyd e Fenix Verde Brac.

Walls with backs in Noce Lloyd and Fenix Verde Brac.

Murs équipés d'un fond en Noce Lloyd et Fenix Verde Brac.





- 1 → Colonne in Fenix Verde Brac.
- 2 → Penisola in Fenix Verde Brac, Top in Gres Fior di Bosco.
- 3 → Pareti attrezzate con schiene in Noce Lloyd e Fenix Verde Brac.

- 1 → Columns in Fenix Verde Brac.
- 2 → Peninsula in Fenix Verde Brac, Top in Fior di Bosco stoneware.
- 3 → Walls with backs in Noce Lloyd and Fenix Verde Brac.

- 1 → Colonnes en Fenix Verde Brac.
- 2 → Îlot en Fenix Verde Brac, plateau en grès Fior di Bosco.
- 3 → Murs équipés d'un fond en Noce Lloyd et Fenix Verde Brac.

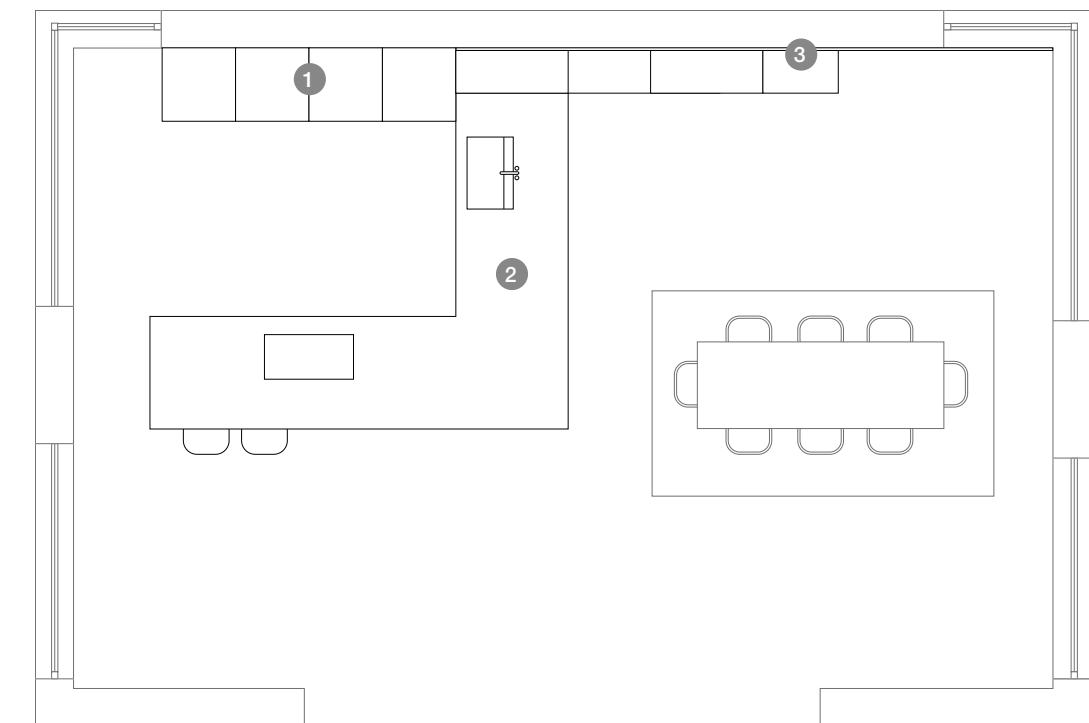



**Una disposizione classica che si adatta a tutte le esigenze.  
Questa composizione è la soluzione ideale per chi vuole valorizzare con gusto anche spazi di dimensioni ridotte.**

**EN.** A classic arrangement that adapts to all needs. This composition is the ideal solution for those seeking to enhance even small spaces with style.

**FR.** Une disposition classique qui s'adapte à tous les besoins. Cette composition est la solution idéale pour ceux qui veulent mettre en valeur avec goût leurs espaces, même de petites dimensions.

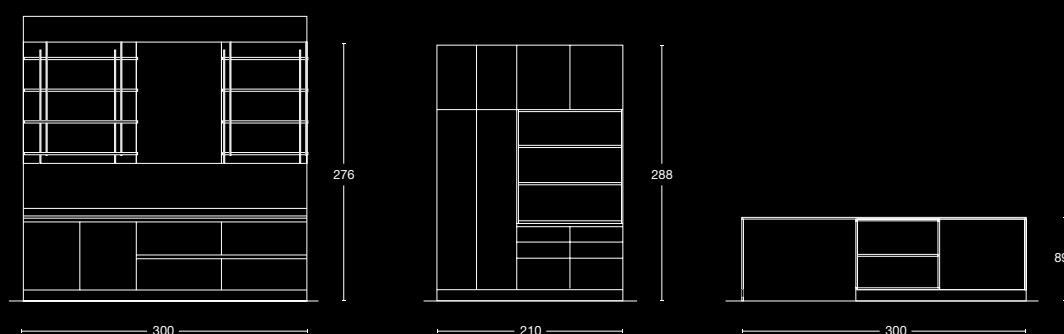

# m.08

Laccato UV Easylak Gloss Grigio Antracite  
Dogato Rovere Yuta  
Top Pietra Acid Iron Opaco









Particolare degli elementi a giorno.  
Piani e schiena in Rovere Yuta.

Detail of the open elements.  
Yuta oak tops and back.

Détail des éléments ouverts.  
Plan et fond en chêne Yuta.







- 1 → Basi a terra in Rovere Yuta, Top Pietra Acid Iron Opaco.
- 2 → Pensili a giorno con struttura in alluminio antracite, schianale e ripiani in Rovere Yuta.
- 3 → Colonne in Laccato UV Easylak Gloss Grigio Antracite.
- 4 → Isola in Laccato UV Easylak Gloss Grigio Antracite, Top in Pietra Acid Iron Opaco.

- 1 → Floor bases in Rovere Yuta, Top in Matt Acid Iron stoneware.
- 2 → Open wall units with structure in anthracite aluminium, back and shelves in Yuta oak.
- 3 → Columns with Grigio Antracite Easylak Gloss UV lacquer.
- 4 → Island with Grigio Antracite Easylak Gloss UV lacquer, Top in Matt Acid Iron Stone.

- 1 → Bases au sol en Rovere Yuta, plateau en pierre Acid Iron mate.
- 2 → Éléments hauts ouverts avec structure en aluminium anthracite, fond et étagères en chêne Yuta.
- 3 → Colonnes en laqué UV Easylak Gloss Grigio Antracite.
- 4 → Îlot en laqué UV Easylak Gloss Grigio Antracite, plateau en pierre Acid Iron mate.

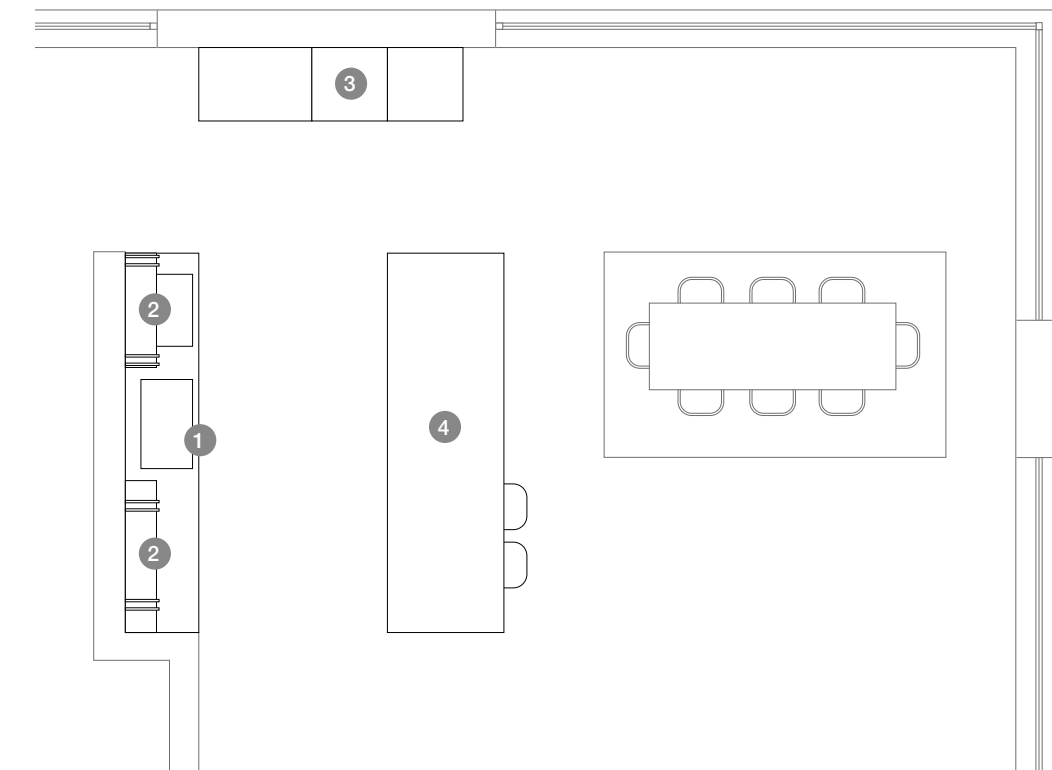

**Estetica e grande capacità.**

**Le aree funzionali contrapposte e accostate garantiscono grande ergonomia e consentono di muoversi nello spazio agevolmente. I pensili si fondono con grandi vani a giorno garantendo una perfetta funzionalità ed organizzazione. La penisola si amplia e diviene tavolo: un accorgimento che aumenta la superficie di lavoro a disposizione.**

**EN. Aesthetics and great capacity.**

Contrasting and side-by-side functional areas guarantee great ergonomics and make moving around easier. The wall units blend together with the big open units providing perfect function and organization. The island widens and becomes a table: a solution that increases the available work space.

**FR. Esthétique et grande capacité.**

Les zones fonctionnelles opposées et juxtaposées garantissent une grande ergonomie et vous permettent de vous déplacer facilement. Les éléments hauts fusionnent avec de grands compartiments ouverts assurant une fonctionnalité et une organisation parfaites. L'îlot s'agrandit et devient une table: un dispositif qui permet d'augmenter la surface de travail disponible.

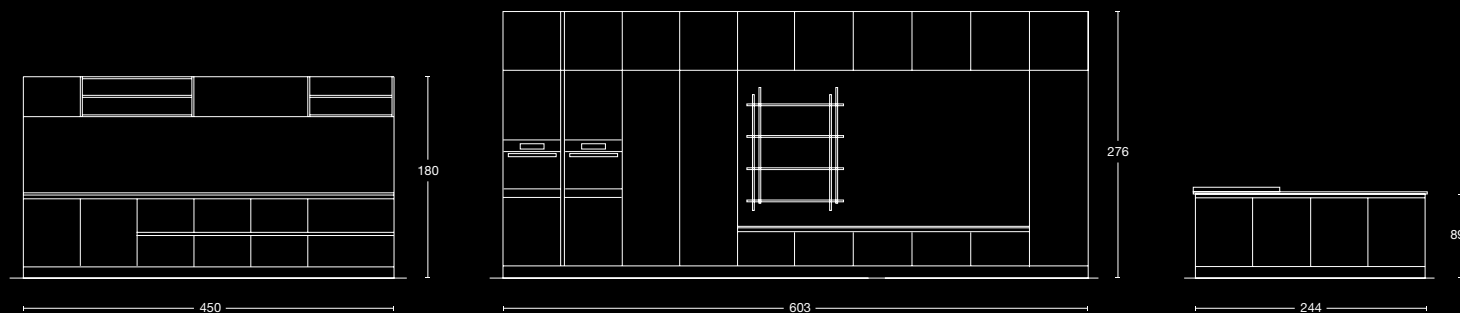

# m.09

Laccato UV Easylak Gloss Grigio Seta  
Dogato Rovere Cacao  
Top Fenix Nero Ingo

















- 1 → Basi a terra in Dogato Rovere Cacao, Top in Fenix Nero Ingo.
- 2 → Pensili in Laccato UV Easylak Gloss Grigio Seta.
- 3 → Pensili a giorno in PET Nero.
- 4 → Colonne, pensili e basi ribassate in Laccato UV Easylak Gloss Grigio Seta, schienale in Rovere Cacao.
- 5 → Isola in Laccato UV Easylak Grigio Antracite, Top in Fenix Nero Ingo.
- 6 → Piano Snack in Fenix Nero Ingo.

- 1 → Floor bases with Rovere Cacao staved effect, Top in Fenix Nero Ingo.
- 2 → Wall units with Grigio Seta Easylak Gloss UV Lacquer
- 3 → Open wall units in PET Nero.
- 4 → Columns, wall units and low bases with Easylak Gloss Silk Gray UV lacquer, back in Rovere Cacao.
- 5 → Island in Grigio Antracite Easylak UV Lacquer, Top in Fenix Nero Ingo.
- 6 → Fenix Nero Ingo Snack Top.

- 1 → Bases au sol en Rovere Cacao Dogato, plateau en Fenix Nero Ingo.
- 2 → Éléments hauts en laqué UV Easylak Gloss Grigio Seta.
- 3 → Éléments hauts ouverts en PET Nero.
- 4 → Colonnes, éléments hauts et bas en laqué UV Easylak Gloss Grigio Seta, fond en Rovere Cacao.
- 5 → Îlot en laqué UV Easylak Gloss Grigio Antracite, plateau en Fenix noir Ingo.
- 6 → Plan snack en Fenix Nero Ingo.

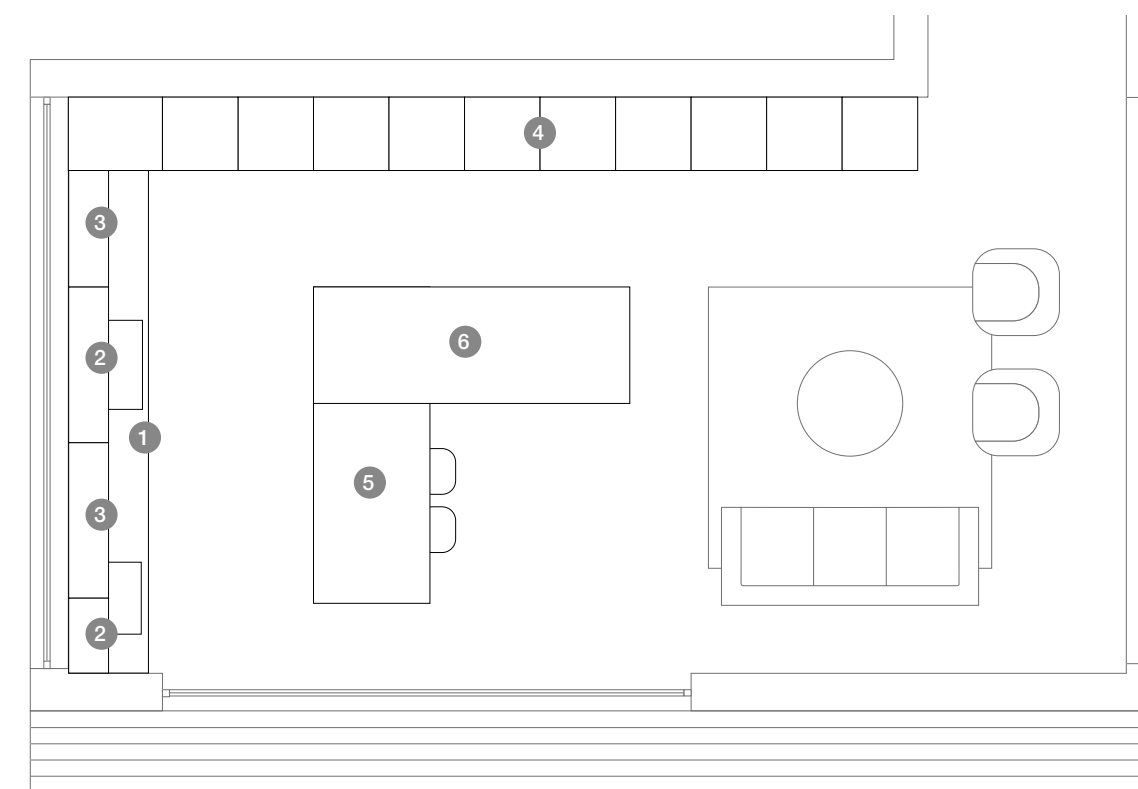



**Contemporanea e versatile.**

**L'utilizzo di grandi pareti attrezzate e di un isola capace di accogliere attività differenti, garantiscono la continua interazione con gli spazi circostanti.**

**Non più solo zona dedicata alla preparazione e al consumo del cibo, ma fulcro di incontri e scambi.**

**EN.** Contemporary and versatile.

The use of large furnished walls and an island that can accommodate different activities ensures continuous interaction with the surrounding space. The kitchen is no longer solely devoted to the preparation and consumption of food, but a hub for encounter and exchange.

**FR.** Contemporain et polyvalent.

L'utilisation de grandes parois équipées et d'un îlot conçu pour accueillir différentes activités garantit l'interaction continue avec les espaces environnants. Ce n'est plus seulement un espace dédié à la préparation et à la consommation de la nourriture. Il devient un lieu de rencontres et d'échanges.

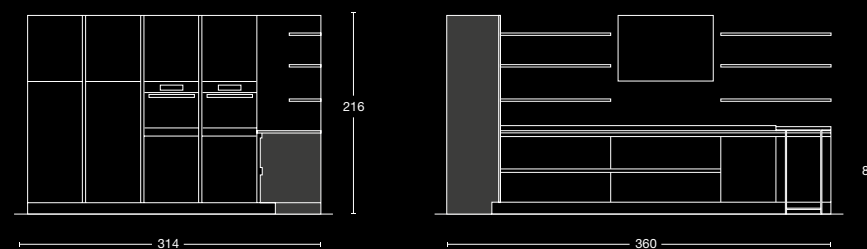

# m.10

Dogato Rovere Grafite  
Laccato UV Easylak Gloss Bianco  
Laccato Opaco Magnolia  
Top Bianco Lucido











Parete attrezzata con struttura in alluminio antracite, ripiani in laccato opaco Magnolia.

Wall with structure in anthracite aluminium, shelves with Magnolia Matt lacquer.

Mur équipé avec structure en aluminium anthracite, étagères en laqué Matt Magnolia.





- 1 → Colonne in Dogato Rovere Grafite.
- 2 → Basi a terra in Dogato Rovere Grafite, Top in Quarzo Bianco Assoluto.
- 3 → Mensole in Laccato Opaco Magnolia.
- 4 → Piano Snack in Quarzo Bianco Assoluto.
- 5 → Pannelli in Laccato UV EasyLak Gloss Bianco.
- 6 → Struttura in alluminio Antracite, ripiani in Laccato Opaco Magnolia.

- 1 → Columns with Rovere Grafite staved effect.
- 2 → Floor bases with Rovere Grafite staved effect, Bianco Assoluto Quartz Top.
- 3 → Shelves with Magnolia Matt lacquer.
- 4 → Bianco Assoluto Quartz Top.
- 5 → Panels with Bianco EasyLak Gloss UV Lacquer.
- 6 → Structure in Anthracite aluminium, shelves with Magnolia Matt lacquer.

- 1 → Colonnes en Rovere Grafite Dogato.
- 2 → Bases au sol en Rovere Grafite Dogato, plateau en Quartz Bianco Assoluto.
- 3 → Étagères en laqué Magnolia Matt.
- 4 → Plan snack en Quartz Bianco Assoluto.
- 5 → Panneaux en laqué UV EasyLak Gloss Bianco.
- 6 → Structure en aluminium antracite, étagères en laqué Matt Magnolia.

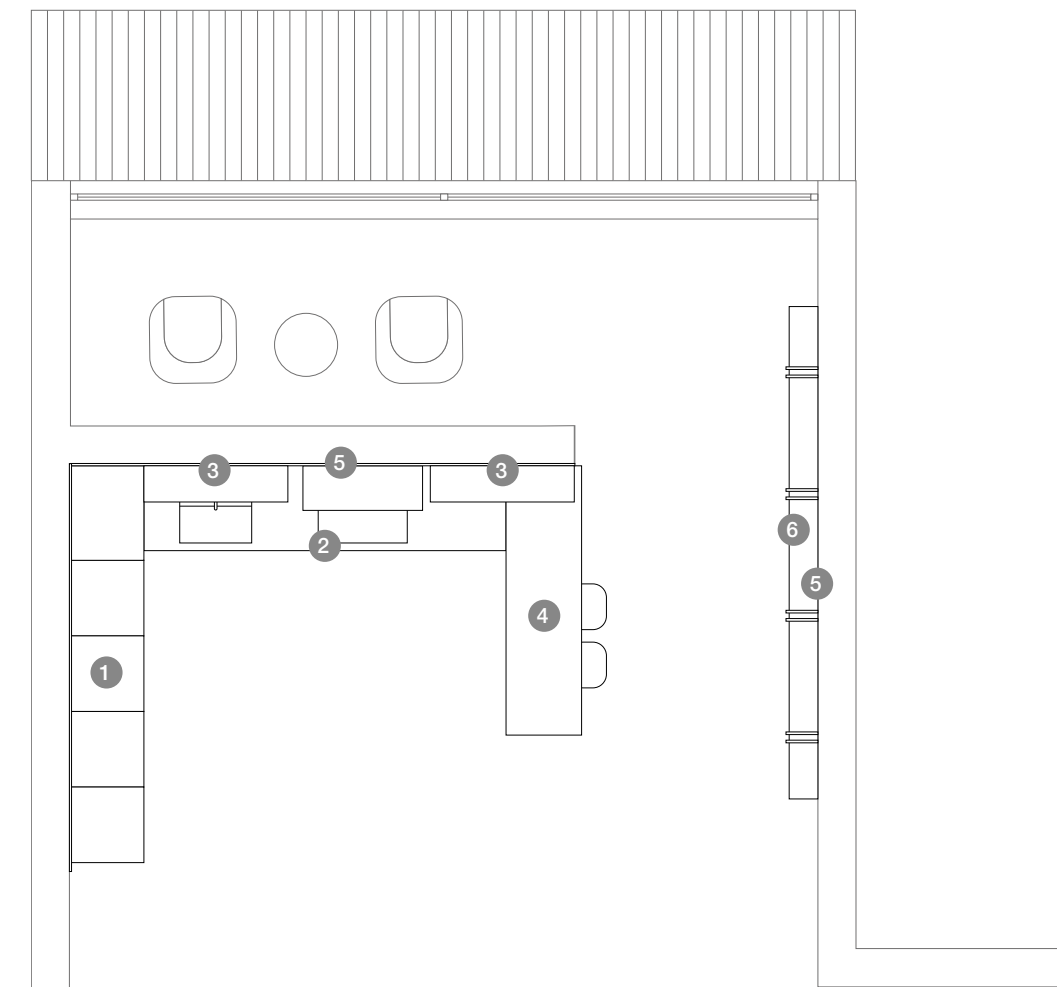

**Scaccomatto**

Excellence Kitchen



**Finiture ricercate ed ecosostenibili: la resina di malta ecologica cemento si combina perfettamente con le tonalità del Fenix Grigio Londra e Nero Ingo, dando vita ad un'estetica raffinata e prestigiosa.**

**Il sistema di ante rientranti sul fianco permette una totale accessibilità ai vani interni, l'avanzato meccanismo ne garantisce un'apertura fluida ed agevole.**

**EN.** Refined and ecologically sustainable finishes: cement resin combines perfectly with the Grigio Londra and Nero Ingo Fenix colours to give life to a refined and prestigious aesthetic.

Total accessibility to the inside is made possible by the fold-away door system. The advanced mechanism guarantees fluidity and is easy-to-use.

**FR.** Finitions raffinées et respectueuses de l'environnement: la résine écologique couleur ciment se combine parfaitement avec les nuances du Fenix Grigio Londra et Nero Ingo, donnant vie à une esthétique raffinée et prestigieuse.

Le système de portes escamotables sur le côté permet une totale accessibilité aux compartiments internes, le mécanisme avancé garantit une ouverture fluide et facile.

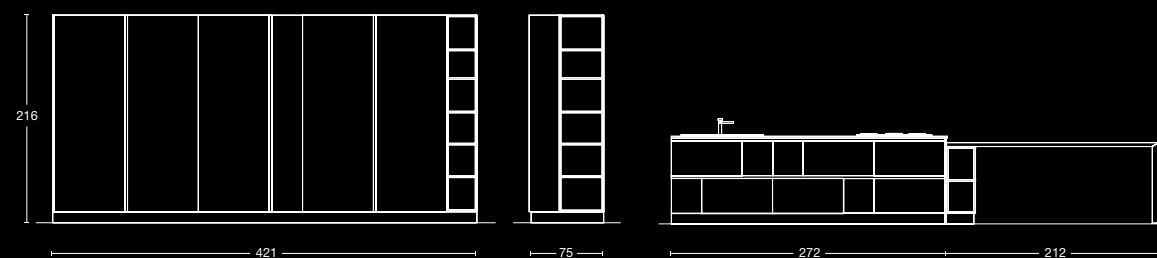

# s.11

Resina Malta Ecologica Ardesia  
Fenix Nero Ingo  
Fenix Grigio Londra  
Rovere Nodato Bianco Artico











Sistemi di apertura per dispense a colonna.  
Ante rientranti a pacchetto.

Door opening systems for tall unit pantries.  
Fold-away cabinet doors.

Systèmes d'ouverture pour garde-manger à  
colonnes. Portes escamotables.





Penisola in Fenix Grigio Londra e Nero Ingo, Top in Fenix Nero Ingo e Piano snack in Rovere Nodato Bianco Artico.

Peninsula in Fenix Grigio Londra and Nero Ingo, Top in Fenix Nero Ingo and Snack Top in Rovere Nodato Bianco Artico.

Îlot en Fenix Grigio Londra et Nero Ingo, plateau en Fenix noir Ingo et plan snack en Rovere Nodato Bianco Artico.







**1** → Colonne in Resina Malta Ecologica Ardesia e Fenix Nero Ingo. Colonna a giorno in Fenix Nero Ingo.  
**2** → Penisola in Fenix Nero Ingo e Grigio Londra, Top in Fenix Nero Ingo.  
**3** → Piano Snack in Rovere Nodato Bianco Artico.

**1** → Columns in Resina Malta Ecologica Ardesia and Fenix Nero Ingo. Open column in Fenix Nero Ingo.  
**2** → Peninsula in Fenix Nero Ingo and Grigio Londra, Top in Fenix Nero Ingo.  
**3** → Rovere Nodato Bianco Artico Snack Top.

**1** → Colonne en résine écologique Ardesia et Fenix Nero Ingo. Colonne ouverte en Fenix Nero Ingo.  
**2** → Îlot en Fenix Nero Ingo et Grigio Londra, plateau en Fenix Nero Ingo.  
**3** → Plan snack en Rovere Nodato Bianco Artico.

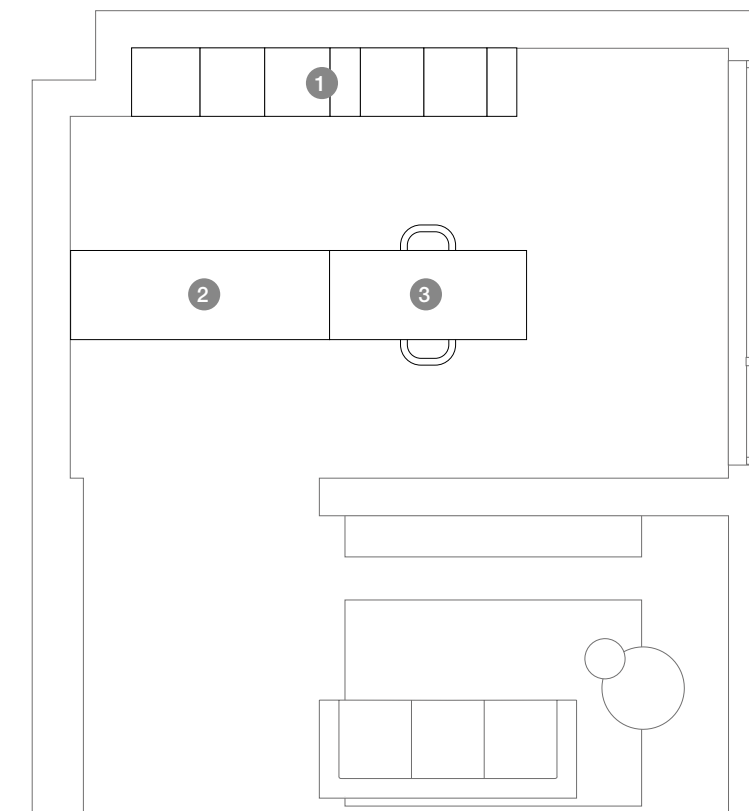

**Forte personalità, essenzialità ed eleganza.**

**La ricchezza delle innovazioni estetiche e di materiali di ultima generazione, fanno di Scacomatto un modello di alta gamma di Spagnol Cucine.**

**L'assenza della maniglia conferisce al progetto una linearità senza pari. Le tonalità del tortora e del castoro Ottawa si legano in perfetta sintonia, creando un piacevole gioco di contrasti tra le superfici lisce del Fenix e quelle graffiate della resina malta ecologia.**

**EN.** Strong character, essential and elegant.

The richness of the aesthetic innovations and state-of-the-art materials make Scacomatto a high-end model by Spagnol Cucine.

The absence of a handle gives the collection a simple line without equal. The dove grey and Ottawa beaver tones unite in perfect harmony creating a pleasant play of contrasts between the smooth Fenix NTM surfaces and the etched surface of the cement resin.

**FR.** Forte personnalité, caractère essentiel et élégance.

La richesse des innovations esthétiques et des matériaux de dernière génération font de Scacomatto un modèle haut de gamme de Spagnol Cucine.

L'absence de la poignée confère au projet une linéarité inégalée. Les nuances de tourterelle et de castor Ottawa se lient en parfaite harmonie, créant un agréable jeu de contrastes entre les surfaces lisses du Fenix et celles rayées de la résine écologique.

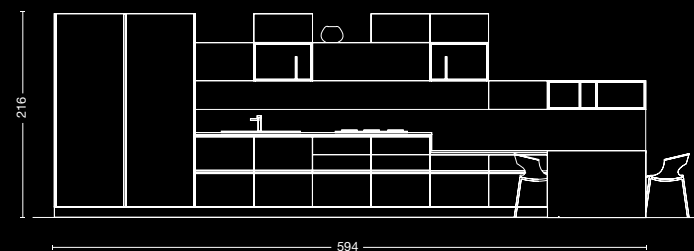

# s.12

Resina Malta Ecologica Tortora  
Fenix Castoro Ottawa  
Rovere Nodato Naturale

















Sistemi di apertura per dispense a colonna.  
Ante rientranti a pacchetto.

Door opening systems for tall unit pantries.  
Fold-away cabinet doors.

Systèmes d'ouverture pour garde-manger à  
colonnes. Portes escamotables.







1 → Colonne in in Resina Malta Ecologica Tortora .  
 2 → Basi a terra in Resina Malta Ecologica Tortora e Fenix Castoro Ottawa, Top in Fenix Castoro Ottawa.  
 3 → Pensili in Resina Malta Ecologica Tortora, pensili a giorno in Fenix Castoro Ottawa.  
 4 → Piano Snack in Rovere Essenza Naturale.

1 → Columns in Resina Malta Ecologica Tortora.  
 2 → Floor bases in Resina Malta Ecologica Tortora and Fenix Castoro Ottawa, Top in Fenix Castoro Ottawa.  
 3 → Wall units in Resina Malta Ecologica Tortora, open wall units in Fenix Castoro Ottawa.  
 4 → Rovere Essenza Naturale Snack Top.

1 → Colonne en résine écologique Tortora.  
 2 → Bases au sol en résine écologique Tortora et Fenix Castoro Ottawa, plateau en Fenix Castoro Ottawa.  
 3 → Éléments hauts en résine écologique Tortora, éléments ouverts en Fenix Castoro Ottawa.  
 4 → Plan snack en Rovere Essenza Naturale.

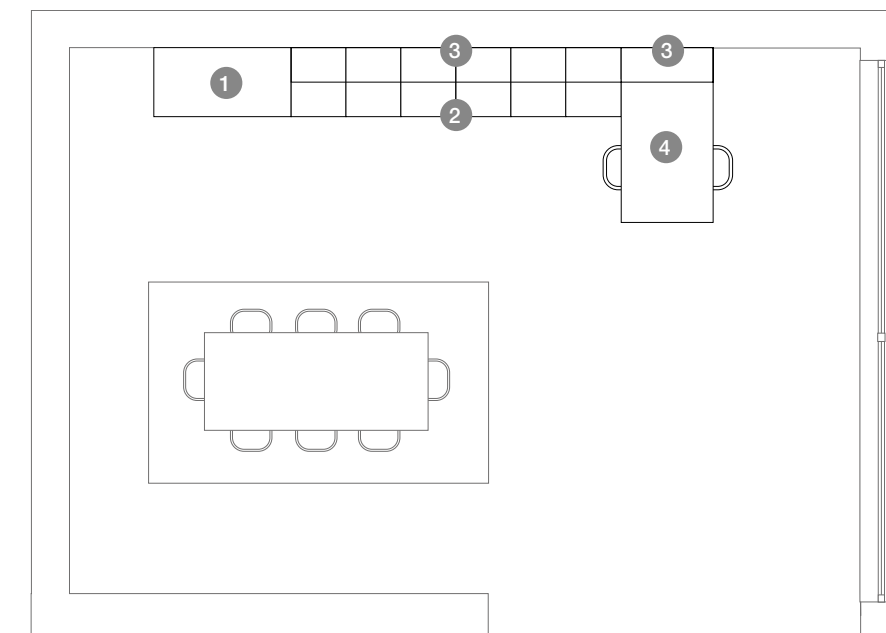

**L'ampia componibilità di Scaccomatto consente di progettare ambienti di design, senza rinunciare alla scelta di attrezzature e materiali professionali. Colonne attrezzate, cestoni, vani a giorno e pensili a tutt'altezza, per garantire una capienza massima. Uno stile puro e rigoroso, sempre contrassegnato da una grande personalità.**

**EN.** Designing environments without having to give up your choice equipment and professional material is possible thanks to Scaccomatto's high level of modularity. Equipped tall units, big open drawers and wall units with various height possibilities guarantee maximum storage.

A pure and meticulous style that is always characterized by a great personality.

**FR.** La grande modularité de Scaccomatto permet de concevoir des environnements design, sans renoncer au choix des équipements et matériaux professionnels. Colonnes équipées, paniers à compartiments ouverts et éléments hauts à pleine hauteur, pour assurer une capacité maximale. Un style pur et rigoureux, toujours marqué par une grande personnalité.

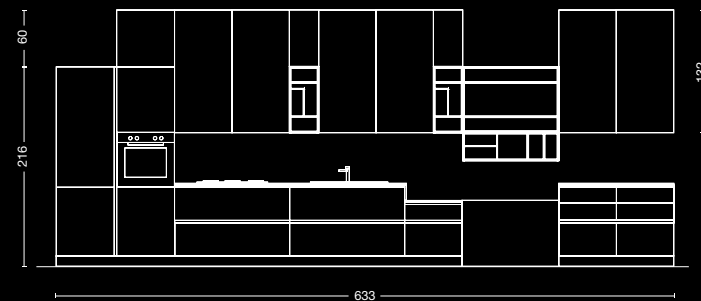

# s.13

Resina Malta Ecologica Cemento  
Fenix Bianco Malè  
Rovere Nodato Gessato Antracite

















Basi in Resina Malta Ecologica Cemento,  
Top in Fenix Bianco Kos.

Bases in Resina Malta Ecologica Cemento,  
Top in Fenix Bianco Kos.

Bases en Résine Écologique Cemento,  
plateau en Fenix Bianco Kos.

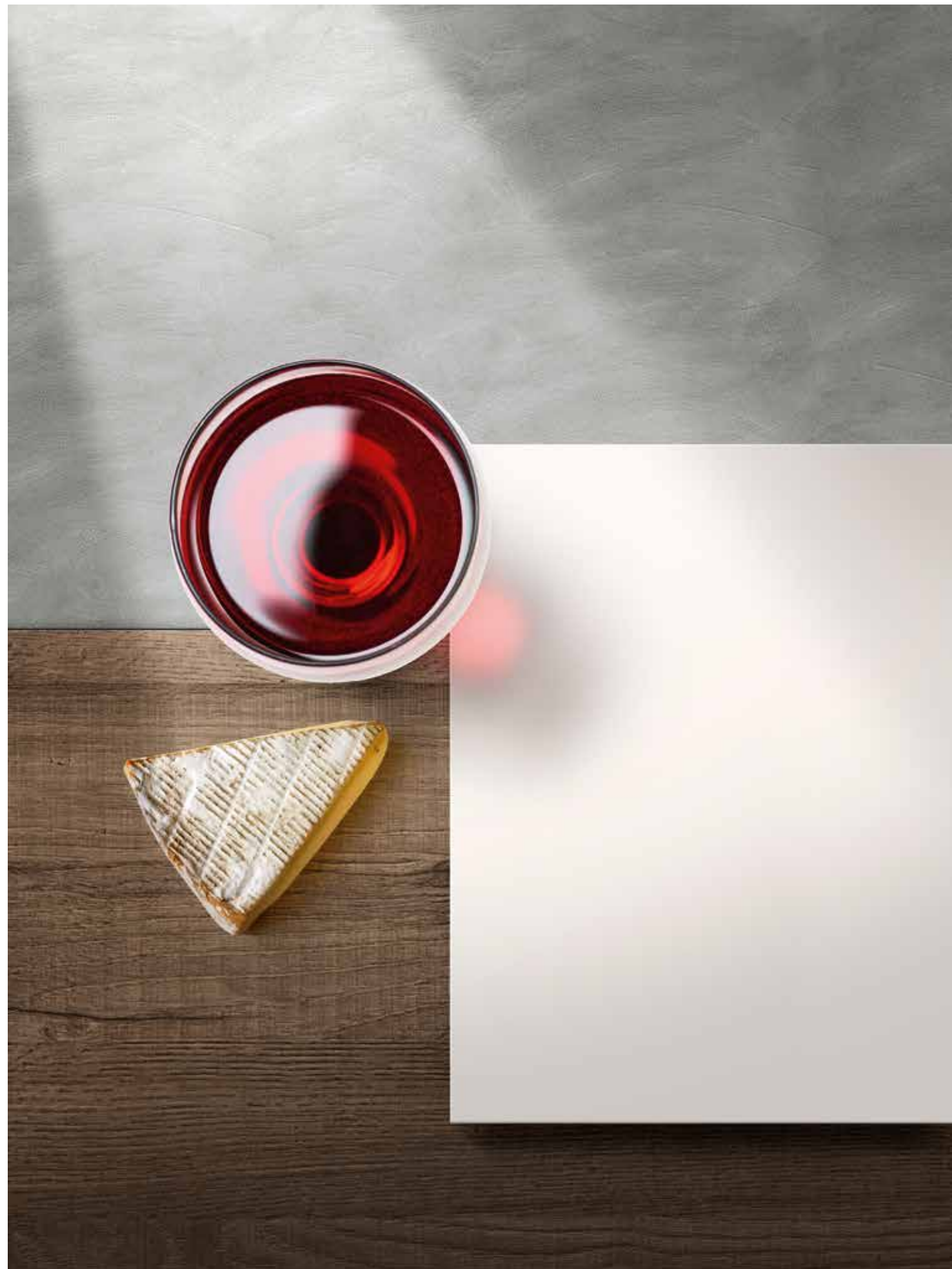

- 1 → Colonne in Resina Malta Ecologica Cemento.
- 2 → Basi a terra in Resina Malta Ecologica Cemento e Fenix Bianco Kos, Top in Fenix Bianco Kos.
- 3 → Pensili in Fenix Bianco Kos.
- 4 → Piano Snack in Rovere Cacao.

- 1 → Columns in Resina Malta Ecologica Cemento.
- 2 → Floor bases in Resina Malta Ecologica Cemento and Fenix Bianco Kos, Top in Fenix Bianco Kos.
- 3 → Wall units in Fenix Bianco Kos.
- 4 → Snack Top in Rovere Cacao.

- 1 → Colonne en résine écologique Cemento.
- 2 → Bases au sol en Resina Malta Ecologica Cemento et Fenix Bianco Kos, plateau en Fenix Bianco Kos.
- 3 → Éléments hauts en Fenix Bianco Kos.
- 4 → Plan snack en Rovere Cacao.

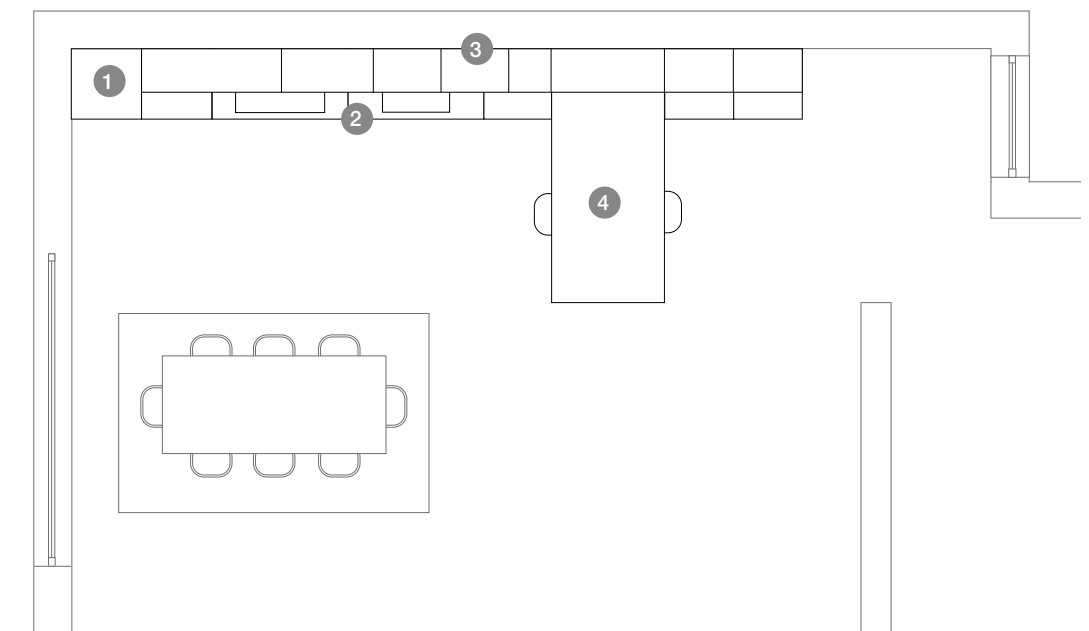



## Maryland m.01



Pag. 42

**Finiture frontali / Front finishes / Finitions avant**  
**Elementi a giorno / Open elements / Eléments ouverts**  
**Pannelli / Panels / Panneaux**  
**Finiture struttura / Frame finishes finition / Finitions structure**  
**Piano isola / Countertop / Plan îlot**  
**Maniglia / Handle / Poignée**

Laccato UV Easylak Gloss Grigio Antracite / Grigio Pietra, Vetro fumè  
 Decorativo Noce Canaletto  
 Gres Sahara Noir Honed  
 Canvas Antracite  
 Gres Sahara Noir Honed, piano snack in Fenix Bianco Kos  
 Gola, Maniglia Mara

## Maryland m.02



Pag. 52

**Finiture frontali / Front finishes / Finitions avant**  
**Elementi a giorno / Open elements / Eléments ouverts**  
**Finiture struttura / Frame finishes finition / Finitions structure**  
**Piano isola / Countertop / Plan îlot**  
**Maniglia / Handle / Poignée**

Laccato UV Easylak Gloss Grigio Seta  
 Decorativo Noce Lloyd  
 Canvas Antracite  
 Gres Ombra di Caravaggio Honed  
 Gola, Maniglia Mara

## Maryland m.03



Pag. 62

**Finiture frontali / Front finishes / Finitions avant**  
**Pannelli / Panels / Panneaux**  
**Finiture struttura / Frame finishes finition / Finitions structure**  
**Piano cucina / Kitchen top / Plan de travail**  
**Maniglia / Handle / Poignée**

Fenix Rosso Askja, Laccato UV Easylak Matt Grigio Pietra, Vetro fumè  
 Decorativo Noce Canaletto  
 Canvas Antracite  
 Quarzo Bianco Assoluto  
 Gola, Maniglia Mara

**Tavolo / Table / Table**  
**Sedie / Chairs / Chaises**

Agile  
 Fuller

## Maryland m.04



Pag. 72

**Finiture frontali / Front finishes / Finitions avant**  
**Elementi a giorno / Open elements / Eléments ouverts**  
**Finiture struttura / Frame finishes finition / Finitions structure**  
**Piano cucina / Kitchen top / Plan de travail**  
**Maniglia / Handle / Poignée**

Laccato UV Easylak Matt Antracite  
 Decorativo Noce Lloyd  
 Canvas Antracite  
 Top Pietra Acid Iron Opaco  
 Gola

## Maryland m.05



Pag. 82

**Finiture frontali / Front finishes / Finitions avant**  
**Elementi a giorno / Open elements / Eléments ouverts**  
**Finiture struttura / Frame finishes finition / Finitions structure**  
**Piano cucina / Kitchen top / Plan de travail**  
**Piano isola / Countertop / Plan îlot**  
**Struttura in metallo / Metal structure / Structure métallique**  
**Maniglia / Handle / Poignée**

Laccato UV Easylak Gloss Bianco, HPL Grey Stone, Vetro fumè  
 Decorativo Noce Lloyd  
 Canvas Antracite  
 Calacatta Gold Honed  
 Calacatta Gold Honed  
 Alluminio Nero opaco  
 Gola, Maniglia Mara

## Maryland m.06



Pag. 94

**Finiture frontali / Front finishes / Finitions avant**  
**Elementi a giorno / Open elements / Eléments ouverts**  
**Pannelli / Panels / Panneaux**  
**Finiture struttura / Frame finishes finition / Finitions structure**  
**Piano cucina / Kitchen top / Plan de travail**  
**Maniglia / Handle / Poignée**

Fenix Nero Ingo / Laccato UV Easylak Matt Bianco  
 Schiena Fenix Nero Ingo, Piani Laccato UV Easylak Matt Bianco,  
 Struttura in alluminio Nero Opaco  
 Decorativo Noce Lloyd  
 Canvas Antracite  
 Calacatta Gold Honed  
 Gola

**Tavolo / Table / Table**

Tavolo Charm

## Maryland m.07



Pag. 104

**Finiture frontali / Front finishes / Finitions avant**  
**Pannelli / Panels / Panneaux**  
**Finiture struttura / Frame finishes finition / Finitions structure**  
**Piano isola / Countertop / Plan îlot**  
**Struttura in metallo / Metal structure / Structure métallique**  
**Maniglia / Handle / Poignée**

Fenix Verde Brac  
 Decorativo Noce Lloyd, Fenix Verde Brac  
 Canvas Antracite  
 Gres Fior di Bosco  
 Alluminio Nero opaco  
 Gola, Maniglia Mara

## Maryland m.08



Pag. 114

**Finiture frontali / Front finishes / Finitions avant**  
**Pannelli / Panels / Panneaux**  
**Finiture struttura / Frame finishes finition / Finitions structure**  
**Piano cucina / Kitchen top / Plan de travail**  
**Piano isola / Countertop / Plan îlot**  
**Struttura in metallo / Metal structure / Structure métallique**  
**Maniglia / Handle / Poignée**

Laccato UV Easylak Gloss Grigio Antracite, Dogato Rovere Yuta  
 Rovere Yuta  
 Canvas Antracite  
 Pietra Acid Iron Opaco  
 Pietra Acid Iron Opaco  
 Alluminio Nero opaco  
 Gola, Maniglia Mara

**Tavolo / Table / Table**  
**Sedie / Chairs / Chaises**

Agile  
 Fuller

## Maryland m.09



Pag. 124

**Finiture frontali / Front finishes / Finitions avant**  
**Elementi a giorno / Open elements / Eléments ouverts**  
**Finiture struttura / Frame finishes finition / Finitions structure**  
**Piano cucina / Kitchen top / Plan de travail**  
**Piano isola / Countertop / Plan îlot**  
**Struttura in metallo / Metal structure / Structure métallique**  
**Maniglia / Handle / Poignée**

Laccato UV Easylak Gloss Grigio Seta, Dogato Rovere Cacao  
 PET Nero  
 Canvas Antracite  
 Fenix Nero Ingo  
 Fenix Nero Ingo  
 Acciaio Brill  
 Gola, Maniglia Mara

**Sedie / Chairs / Chaises**

Fuller

## Maryland m.10



Pag. 134

**Finiture frontali / Front finishes / Finitions avant**  
**Pannelli / Panels / Panneaux**  
**Mensole / Shelves / Étagères**  
**Finiture struttura / Frame finishes finition / Finitions structure**  
**Piano cucina / Kitchen top / Plan de travail**  
**Struttura in metallo / Metal structure / Structure métallique**  
**Maniglia / Handle / Poignée**

Dogato Rovere Grafite  
 Laccato UV Easylak Gloss Bianco  
 Laccato opaco Magnolia  
 Canvas Antracite  
 Quarzo Bianco Assoluto  
 Alluminio Nero opaco  
 Gola, Maniglia Mara

## Scaccomatto s.12



Pag. 146

**Finiture frontali / Front finishes / Finitions avant**  
**Elementi a giorno / Open elements / Eléments ouverts**  
**Finiture struttura / Frame finishes finition / Finitions structure**  
**Piano cucina / Kitchen top / Plan de travail**  
**Piano isola / Countertop / Plan îlot**  
**Maniglia / Handle / Poignée**

Resina Malta Ecologica Ardesia, Fenix Grigio Londra/Nero Ingo  
Fenix Nero Ingo  
Canvas  
Fenix Nero Ingo  
Rovere Nodato Bianco Artico  
Gola

## Scaccomatto s.13



Pag. 160

**Finiture frontali / Front finishes / Finitions avant**  
**Elementi a giorno / Open elements / Eléments ouverts**  
**Finiture struttura / Frame finishes finition / Finitions structure**  
**Piano cucina / Kitchen top / Plan de travail**  
**Piano isola / Countertop / Plan îlot**  
**Maniglia / Handle / Poignée**

Resina Malta Ecologica Tortora, Fenix Castoro Ottawa  
Fenix Castoro Ottawa  
Canvas  
Fenix Castoro Ottawa  
Rovere Essenza Naturale  
Gola

## Scaccomatto s.14



Pag. 176

**Finiture frontali / Front finishes / Finitions avant**  
**Elementi a giorno / Open elements / Eléments ouverts**  
**Finiture struttura / Frame finishes finition / Finitions structure**  
**Piano cucina / Kitchen top / Plan de travail**  
**Piano isola / Countertop / Plan îlot**  
**Maniglia / Handle / Poignée**

Resina Malta Ecologica Cemento, Fenix Bianco Malè  
Fenix Bianco Malè  
Bianco  
Fenix Bianco Malè  
Rovere Cacao  
Gola



## Furnishing accessories

## Agile

**Tavolo realizzato con piani rettangolari in laminato e gambe in tecnopolimero in diverse colorazioni.**

Table available with rectangular solid laminate tops and techno-polymer leg in different colors.

Table réalisée avec des plateaux rectangulaires en stratifié et des pieds en technopolymère de différentes couleurs.



### Colore struttura tecnopolimero

Technopolymer frame color  
Couleur structure technopolymère



### Colore piano laminato

Laminated top color  
Couleur plan laminé



## Charm

**Tavolo con piano Iron e struttura in metallo verniciato.**

Iron table top, painted metal frame.

Table avec plateau Iron et structure en métal peint.



### Colori

Colors  
Couleurs



## Saturno

**Tavolo con piano Compactop e struttura in alluminio verniciato.**

Compactop with painted aluminum frame.

Table avec plateau Compactop et structure en aluminium peint.



### Colore Base

Base color  
Couleur de la base

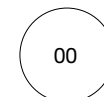

### Colore Piano

Top color  
Couleur du plan

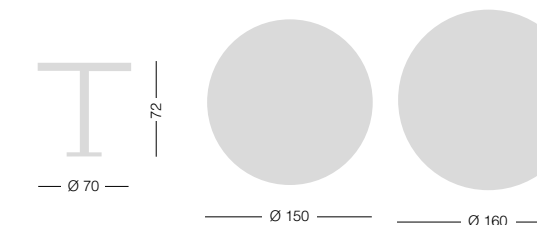
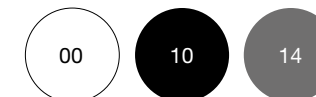



## Fuller

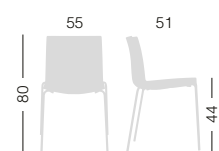

**FULLER NA**  
**Struttura 4 gambe in metallo verniciata, scocca in tecnopolimero.**  
 Painted 4-legged metal frame, techno-polymer shell.  
 Structure à 4 pieds en métal peint, coque en technopolymère.

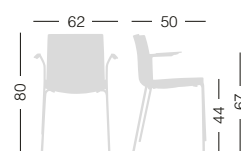

**FULLER B**  
**Struttura 4 gambe in metallo verniciata con braccioli, scocca in tecnopolimero.**  
 Painted 4-legged metal frame with armrests, techno-polymer shell.  
 Structure 4 pieds en métal peint avec accoudoirs, coque en technopolymère.

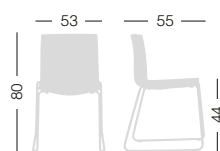

**FULLER ST**  
**Struttura a slitta verniciata in metallo, scocca in tecnopolimero.**  
 Painted sled metal frame, techno-polymer shell.  
 Structure à dossier peint en métal, coque en technopolymère.

## Bakhita

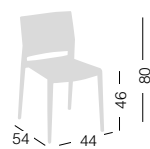

**BAKHITA**  
**Sedia bi-materiale in tecnopolimero.**  
 Twin-material technopolymer chair.  
 Chaise bi-matière en technopolymère.

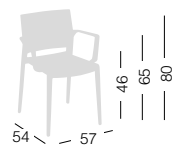

**BAKHITA B**  
**Sedia bi-materiale in tecnopolimero con braccioli integrati.**  
 Techno polymer chair with integrated armrests.  
 Chaise bi-matière en technopolymère avec accoudoirs intégrés.

## Isidora

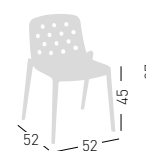

**ISIDORA**  
**Seduta impilabile in tecnopolimero.**  
 4-legged stackable technopolymer chair.  
 Chaise empilable en technopolymère.

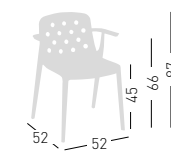

**ISIDORA B**  
**Seduta impilabile in tecnopolimero con braccioli.**  
 4-legged stackable technopolymer chair with armrests.  
 Chaise empilable en technopolymère avec accoudoirs.

## Dress Isidora

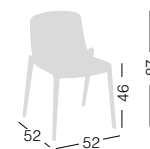

**DRESS ISIDORA**  
**Seduta in tecnopolimero rivestita.**  
 Technopolymer upholstered chair.  
 Chaise en technopolymère recouverte.

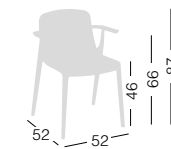

**DRESS ISIDORA B**  
**Seduta in tecnopolimero rivestita con braccioli.**  
 Technopolymer upholstered chair with armrests.  
 Chaise en technopolymère recouverte avec accoudoirs.

## Kanvas

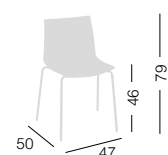
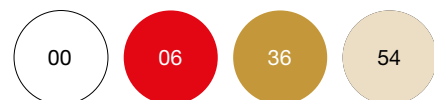
**KANVAS NA**

**Struttura in metallo 4 gambe, cromata, verniciata nera o bianca, scocca in tecnopolimero.**

Chromed, black or white painted 4-Legged metal frame, techno polymer shell.

Structure en métal à 4 pieds, chromée, peinte en noir ou blanc, coque en technopolymère.

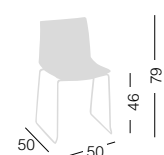
**KANVAS S**

**Struttura a slitta in filo, cromata, verniciata nera o bianca, scocca in tecnopolimero.**

Chromed, black or white painted wire steel sled frame, techno polymer shell.

Structure à dossier en fil, chromée, peinte en noir ou blanc, coque en technopolymère.

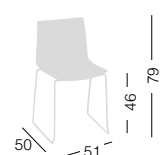
**KANVAS ST**

**Struttura a slitta, cromata o verniciata, scocca in tecnopolimero.**

Chromed or painted sled steel frame, techno polymer shell.

Structure à dossier, chromée ou peinte, coque en technopolymère.

## Alhambra

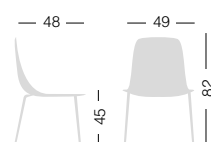
**ALHAMBRA NA**

**Struttura in metallo 4 gambe, cromata, verniciata nera o bianca, scocca in tecnopolimero multicolore.**

Chromed, black or white painted 4-Legged metal frame, techno polymer multicolor shell.

Structure en métal à 4 pieds, chromée, peinte en noir ou blanc, coque en technopolymère multicolore.

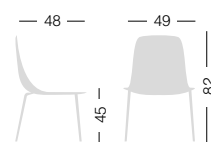
**ALHAMBRA TP**

**Struttura in tecnopolimero 4 gambe bianca o nera, scocca in tecnopolimero multicolore.**

Techno polymer 4-Legged frame, black or white, techno polymer multicolor shell.

Structure en technopolymère 4 pieds, blanche ou noire, coque en technopolymère multicolore.

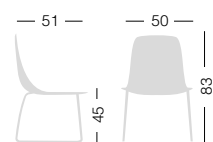
**ALHAMBRA S**

**Struttura a slitta in filo, cromata o verniciata nera o bianca, scocca in tecnopolimero multicolore.**

Chromed, black or white painted wire steel sled frame, techno polymer multicolor shell.

Structure à dossier en fil, chromée, peinte en noir ou blanc, coque en technopolymère multicolore.

## Blog

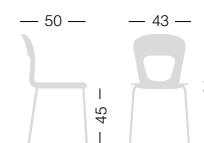
**BLOG**

**Struttura in metallo 4 gambe, cromata o verniciata bianca, scocca in tecnopolimero multicolore.**

Chromed or white painted 4-Legged metal frame, technopolymer multicolor shell

Structure en métal à 4 pieds, chromée ou peinte en blanc, coque en technopolymère multicolore.

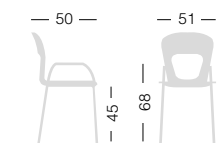
**BLOG TB**

**Struttura in metallo 4 gambe con braccioli, cromata, scocca in tecnopolimero multicolore.**

Chromed 4-Legged metal frame with armrests, techno polymer multicolor shell.

Structure en métal à 4 pieds avec accoudoirs, chromée, coque en technopolymère multicolore.

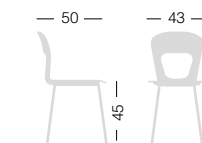
**BLOG BL**

**Struttura in legno di faggio 4 gambe, scocca in tecnopolimero multicolore.**

4-Legged wooden beech frame, techno polymer multicolor shell.

Structure en bois de hêtre à 4 pieds, coque en technopolymère multicolore.

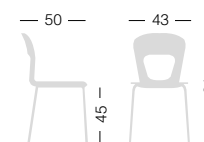
**BLOG NA Upholstered**

**Scocca in tecnopolimero rivestito in tessuto King o pelle. Telaio in metallo cromato o verniciato.**

Techno polymer shell upholstered by King fabric or leather. Chromed or painted metal frame.

Coque en technopolymère recouverte de tissu King ou de cuir. Structure en métal chromé ou peint.

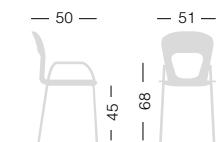
**BLOG TB Upholstered**

**Scocca in tecnopolimero rivestito in tessuto King o pelle. Telaio in metallo cromato con braccioli.**

Techno polymer shell upholstered by King fabric or leather. Chromed metal frame with arms.

Coque en technopolymère recouverte de tissu King ou de cuir. Structure en métal chromé avec accoudoirs.

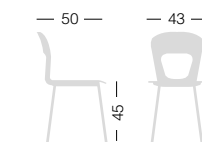
**BLOG BL Upholstered**

**Scocca in tecnopolimero rivestito in tessuto King o pelle e gambe in legno di faggio.**

Techno polymer shell upholstered by King fabric or leather and beech wooden legs.

Coque en technopolymère recouverte de tissu King ou de cuir et pieds en bois de hêtre.



## Kanvas Lounge

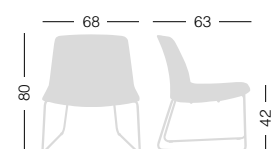
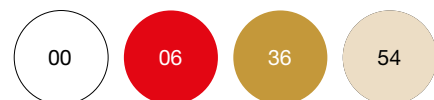

### KANVAS LOUNGE ST

Struttura a slitta in metallo, cromata o verniciata, scocca rivestita.

Chromed or Painted metal sled frame, upholstered shell.  
Structure à dossier en métal, chromée ou peinte, coque recouverte.

## Bakhita Stool

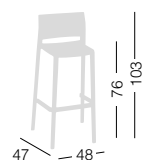

### BAKHITA 76

Sgabello impilabile in co-iniezione polimero-metallo.

Co-injected metal-polymer stackable stool.

Tabouret empilable en co-injection polymère-métal.

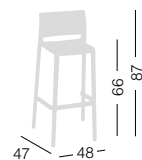

### BAKHITA 66

Sgabello impilabile in co-iniezione polimero-metallo.

Co-injected metal-polymer stackable stool.

Tabouret empilable en co-injection polymère-métal.

## Kanvas Stool

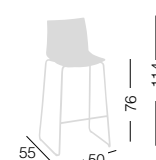

### KANVAS ST 76

Sgabello impilabile in co-iniezione polimero-metallo.

Co-injected metal-polymer stackable stool.

Tabouret empilable en co-injection polymère-métal.

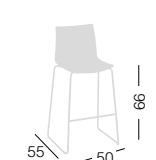

### KANVAS ST 66

Sgabello impilabile in co-iniezione polimero-metallo.

Co-injected metal-polymer stackable stool.

Tabouret empilable en co-injection polymère-métal.

## Alhambra Stool

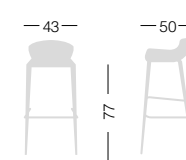
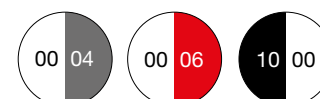

### ALHAMBRA 77

Seduta in tecnopolimero, telaio cromato o verniciato per esterno.

Techno-polymer seat, chromed or outdoor painted frame.

Chaise en technopolymère, structure chromée ou peinte pour l'extérieur.

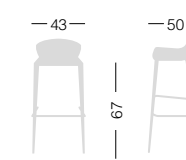

### ALHAMBRA 67

Seduta in tecnopolimero, telaio cromato o verniciato per esterno.

Techno-polymer seat, chromed or outdoor painted frame.

Chaise en technopolymère, structure chromée ou peinte pour l'extérieur.

## Isidoro Stool

00

14

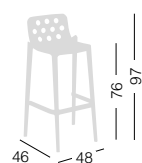

**ISIDORO 76**  
Sgabello impilabile in co-iniezione polimero-metallo.  
Co-injected metal-polymer stackable stool.  
Tabouret empilable en co-injection polymère-métal.

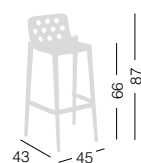

**ISIDORO 66**  
Sgabello impilabile in co-iniezione polimero-metallo.  
Co-injected metal-polymer stackable stool.  
Tabouret empilable en co-injection polymère-métal.



**ISIDORO 76 Upholstered**  
Sgabello in co-iniezione polimero-metallo rivestito.  
Upholstered co-injected metal-polymer stool.  
Tabouret en co-injection métal-polymère revêtu.

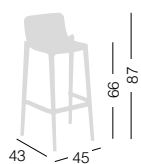

**ISIDORO 66 Upholstered**  
Sgabello in co-iniezione polimero-metallo rivestito.  
Upholstered co-injected metal-polymer stool.  
Tabouret en co-injection métal-polymère revêtu.





## Kitchen modularity





## Modularità Basi

Una panoramica completa delle basi Maryland e della loro modularità.

A complete overview of the Maryland base units and their combinations.

Un aperçu complet des modules de base Maryland et de leur modularité.

### BASI

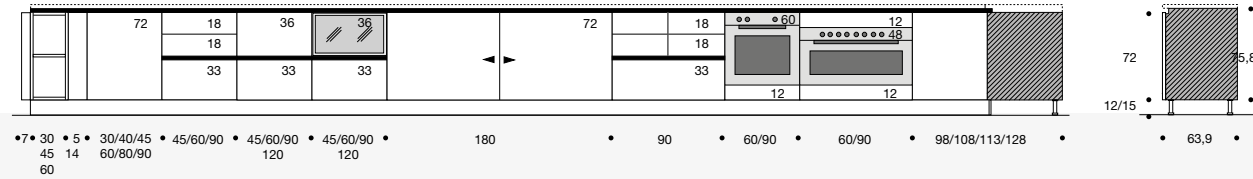

### BASI ATTREZZATE

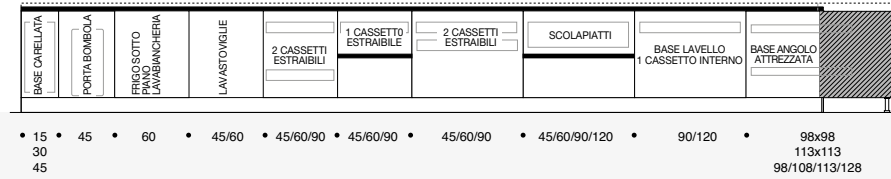

### BASI PROFONDITÀ RIDOTTA / BASI MIDI

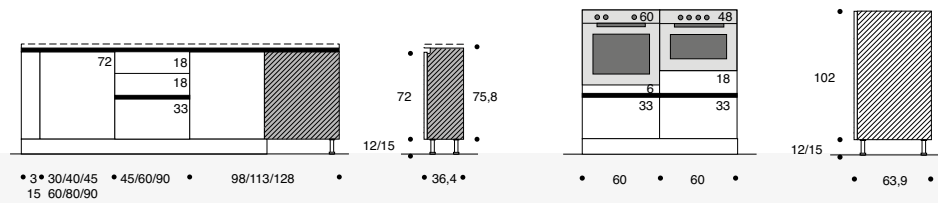

### BASI SOPPESE

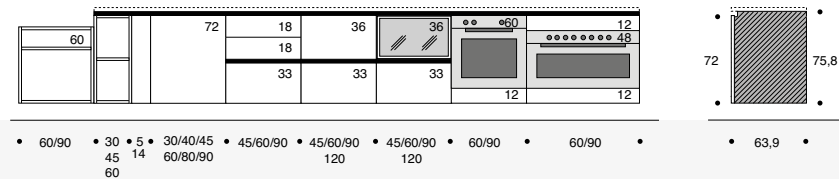

### BASI RIBASSATE

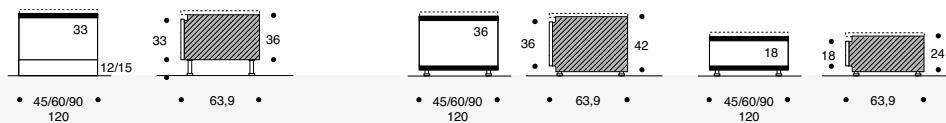

## Modularità Pensili

Qui di seguito una lettura veloce della programmazione del pensilame a "carrello".

A brief overview of the available wall units is given below.

Voici une lecture rapide de la programmation de l'élément à « charriot »

### PENSILI H 36/42/60, PENSILI H 72/102cm

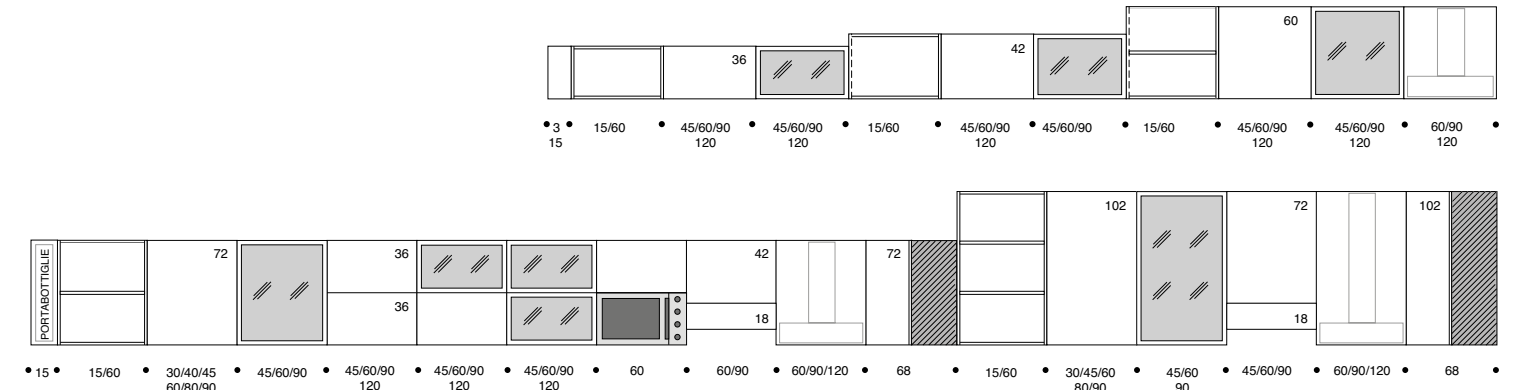

### PENSILI IN METALLO

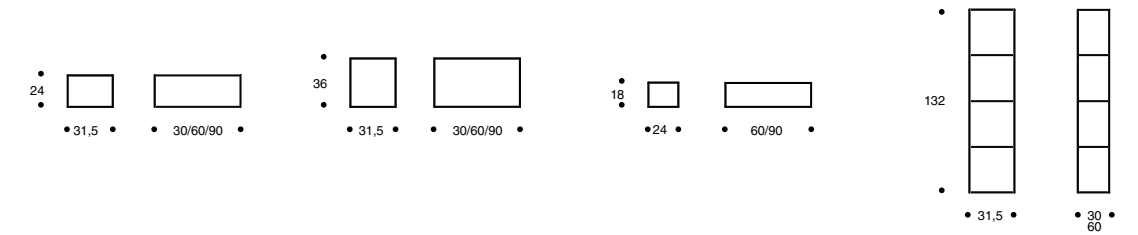

### SOPRAPENSILI / SOPRACOLONNE

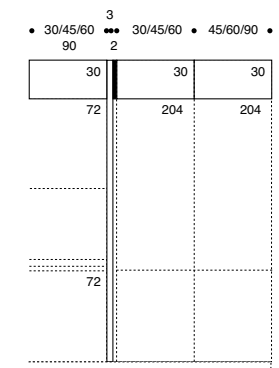

## Modularità Accessori in Metallo

Una panoramica completa delle nuove strutture in metallo abbinabili a Maryland.

A complete overview of the new metal structures which can be combined with Maryland.

Un aperçu complet des nouvelles structures métalliques à combiner avec Maryland.

### STRUTTURE IN METALLO

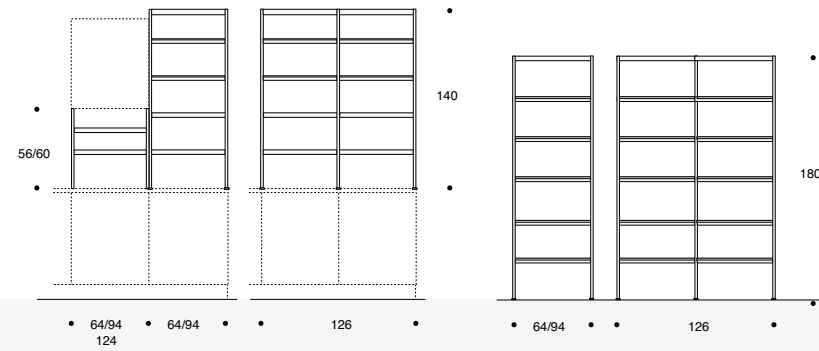

### STRUTTURE IN METALLO

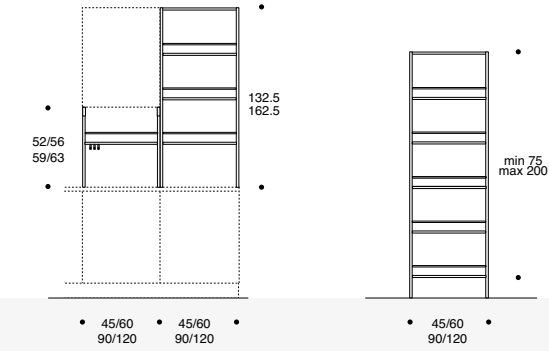

### STRUTTURE IN METALLO E LEGNO

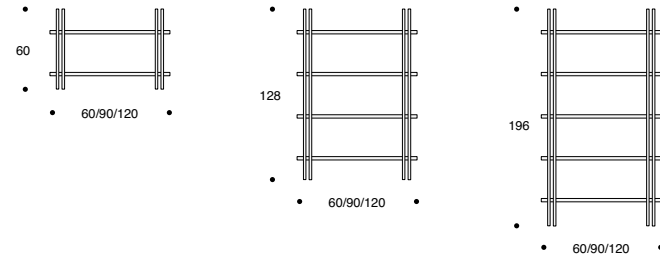





## Modularità Basi

Una panoramica completa delle basi Scacomatto e della loro modularità.

A complete overview of the Scacomatto base units and their combinations.

Un aperçu complet des modules de base Scacomatto et de leur modularité.

### BASI

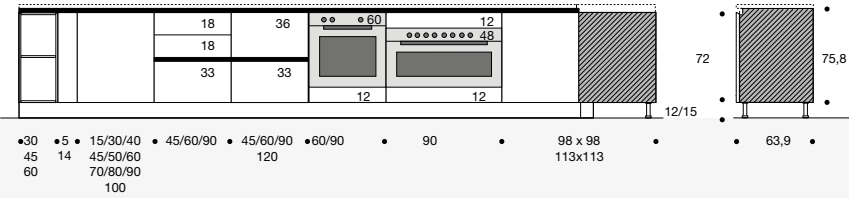

### BASI ATTREZZATE

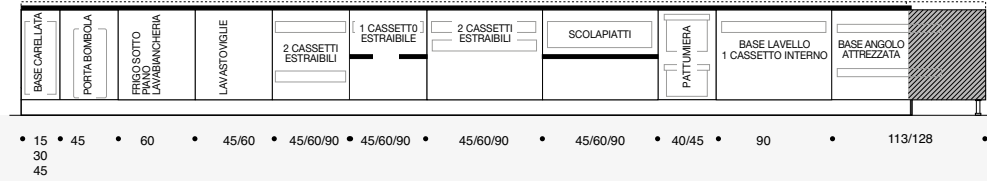

### BASI PROFONDITÀ RIDOTTA / BASI MIDI

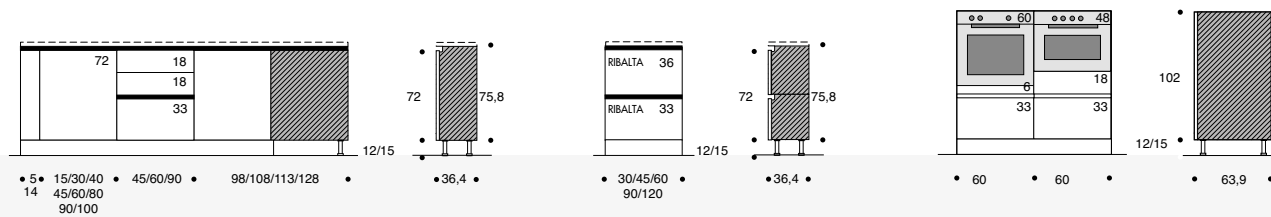

### BASI SOPPESE

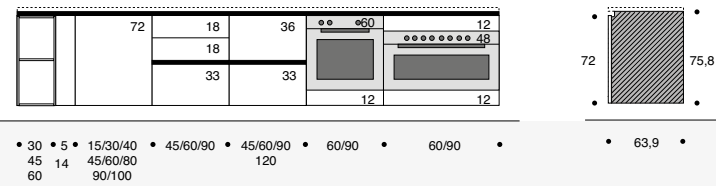

### BASI RIBASSATE

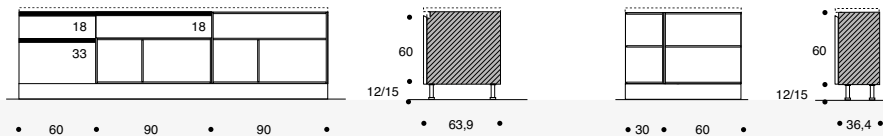

## Modularità Pensili

Qui di seguito una lettura veloce della programmazione del pensilame a "carrello".

A brief overview of the available wall units is given below.

Voici une lecture rapide de la programmation de l'élément à « charriot ».

### PENSILI H 36/42/60, PENSILI H 72/102cm

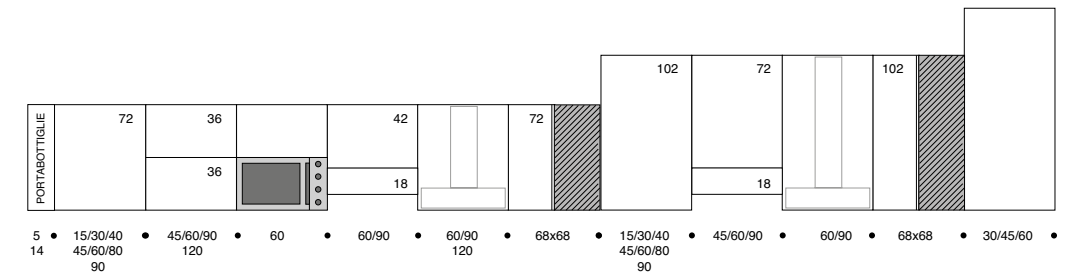
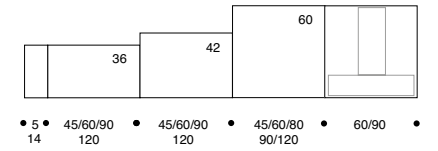

### SOPRAPENSILI / SOPRACOLONNE

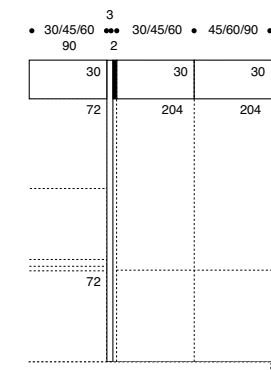



## Modularità Pensili

### PENSILI A GIORNO "JUMPY"

SP.12 MM (ORIZZONTALE)

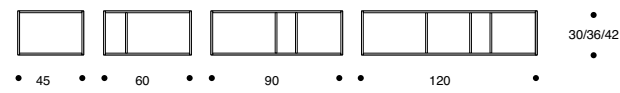

SP.12 MM (VERTICALE)

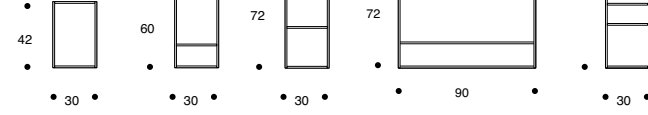

### PENSILI A GIORNO "JUMPY" + "DADO"

(ORIZZONTALE 1)

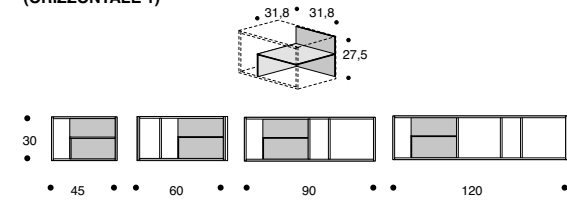

(ORIZZONTALE 2)

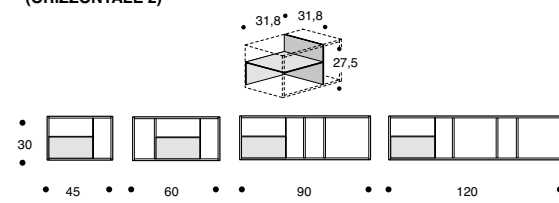

(VERTICALE)

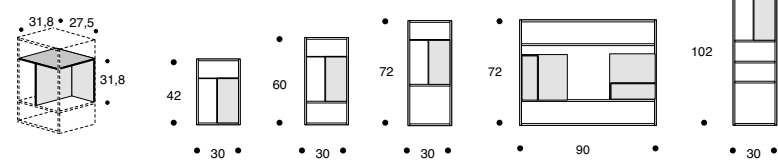

Top



## Proprietà e qualità

- Praticità e resistenza
- Impermeabilità ad acqua e vapore
- Resistenza a limone, olii e acidi alimentari
- Termoresistenza al calore fino a 180°
- Igiene
- Idoneità al contatto con alimenti

### Properties and qualities

- Practicality and resistance, impermeability to water and steam
- Resistance to lemon, oils and food acids, heat resistance up to 180°
- Hygienic, suitability for contact with food.

### Propriété et qualité

- Praticité et résistance, imperméable à l'eau et à la vapeur, résistance au citron, aux huiles et aux acides alimentaires, résistance à la chaleur jusqu'à 180 °c, hygiène, adapté au contact alimentaire.





## Inserimento elettrodomestici

— Le caratteristiche tecniche dei piani come l'impermeabilità e la resistenza al calore consentono l'utilizzo di elettrodomestici a incasso, filotop, sottotop e integrato.

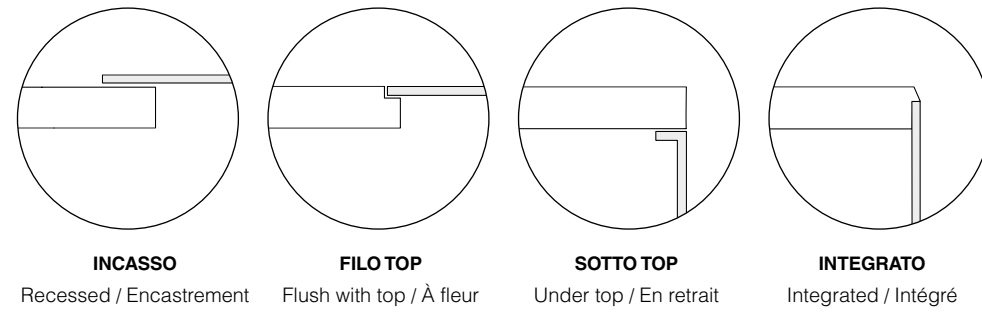

### Insertion of Appliances

— The technical characteristics of the shelves such as waterproofing and heat resistance allow the use of built-in, flush-mount, undermount and integrated appliances.

### Insertion d'appareils électro-ménagers

— Les caractéristiques techniques des plans telles que l'étanchéité et la résistance à la chaleur permettent l'utilisation d'appareils électro-ménagers encastrés posés à fleur, en retrait et intégrés.



## Tipologie Top

— Tre sono le varianti di top proposte, tra loro differenti per spessore e lavorazione.



**Piano scatolato rinforzato con multistrato di pioppo.**  
Permette di realizzare piani di forte spessore (da 20 mm a 160 mm).

Box top reinforced with poplar plywood.  
The shelves can be fairly thick (20 mm to 160 mm).

Plan renforcé de contreplaqué de peuplier.  
Il vous permet de créer des étagères épaisses (de 20 mm à 160 mm).



**Interamente in HPL stratificato, dall'immagine minimale ed essenziale.**  
Permette di realizzare anche forme curve. (spessore 12 mm).

Entirely in stratified HPL, with a minimal and essential look.  
It can also have contoured sections (12 mm thick).

Entièrement en HPL stratifié, avec une image minimale et essentielle.  
Il vous permet également de créer des formes courbes. (épaisseur 12 mm).



**Ha le stesse potenzialità e gli stessi requisiti tecnici, ma è caratterizzato da un taglio terminale a smusso che ne enfatizza l'eleganza (spessore 12 mm).**

It has the same potential and technical requirements, but is characterised by a more sophisticated bevel end cut (12 mm thick).

Il a le même potentiel et les mêmes exigences techniques, mais se caractérise par une coupe en biseau qui souligne son élégance (12 mm d'épaisseur).

## Vasche integrate squadrate

— I top in HPL permettono l'applicazione di vasche integrate squadrate di varie misure, nella stessa finitura scelta per il piano. Sono disponibili con fondo in acciaio inox in tutte le varianti di colore e con fondo in HPL in alcune colorazioni. L'uso di vasche integrate in HPL regala continuità e armonia all'estetica dell'ambiente cucina.

### Integrated square sinks

— The HPL tops can be fitted with integrated square sinks of various sizes, in the same finish chosen for the top. They are available with a stainless steel bottom in all colour variations and with HPL bottom in some colours. The integrated HPL sinks lend continuity and harmony to the aesthetics of the kitchen environment.

### Bacs carrés intégrés

— Les plateaux en HPL permettent l'application de bacs carrés intégrés de différentes tailles, dans la même finition que celle choisie pour le plan. Ils sont disponibles avec un fond en acier inoxydable dans toutes les variations de couleurs et avec fond HPL dans certaines couleurs. L'utilisation de bac HPL intégrés donne continuité et harmonie à l'esthétique de la cuisine.

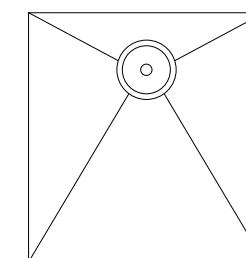

H 360 mm

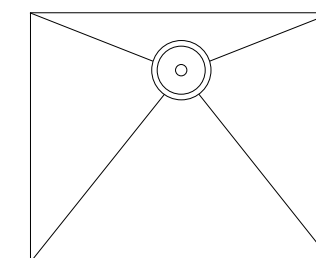

H 680 mm

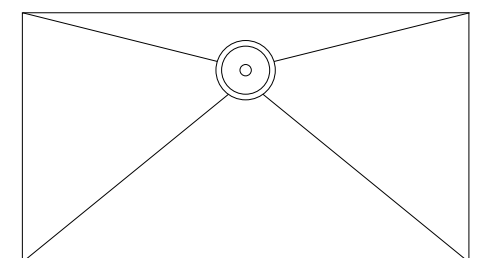

H 680 mm



↓ **Vasca in acciaio inox 450 x 400 mm  
integrata al top.**

Stainless steel sink measuring 450 x 400 mm integrated in the top.  
Bac en acier inoxydable 450 x 400 mm intégré au plateau.

↘ **Vasche integrate H360 in HPL con fondo  
in acciaio inox.**

H360 integrated tanks in HPL with bottom in stainless steel.  
Bacs intégrés H360 en HPL avec fond en acier inoxydable.





Top spessore 12 mm in HPL Grey Stone con giunte a 45° piano e spalle.  
Ante in laminato finitura Grey Stone.  
Vasca in acciaio inox 450 x 400 mm integrata al top



12 mm thick top in HPL Grey Stone with 45° flat and shoulder joints. Laminate doors with Grey Stone finish.  
450 x 400 mm stainless steel sink integrated in the top.

Plateau de 12 mm d'épaisseur en HPL Grey Stone avec joints à 45° plats et à épaulements. Portes en stratifié Grey Stone.  
Bacs en acier inoxydable de 450 x 400 mm intégré dans le plateau.







↑ Top A spessore 80 mm in HPL Grafite Brown e ante in laminato nella stessa finitura.

→ Vasca integrata H 460 mm in HPL Grafite Brown con fondo in acciaio inox

↑ Top A, 80 mm thick and in HPL Grafite Brown, and laminate doors in the same finish.  
→ H 460 mm integrated sink in HPL Grafite Brown with stainless steel bottom.

↑ Plateau de 80 mm d'épaisseur en HPL Graphite Brown et portes stratifiées dans la même finition.  
→ Bac intégré H460 en HPL Graphite Brown avec fond en acier inoxydable.



# Finishes



## Laccati UV EasyLak sp.22mm

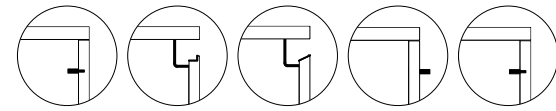

**MATT** Finitura laccata opaca soft touch / Soft touch Matt lacquered finish / Finition laquée mate douce au toucher

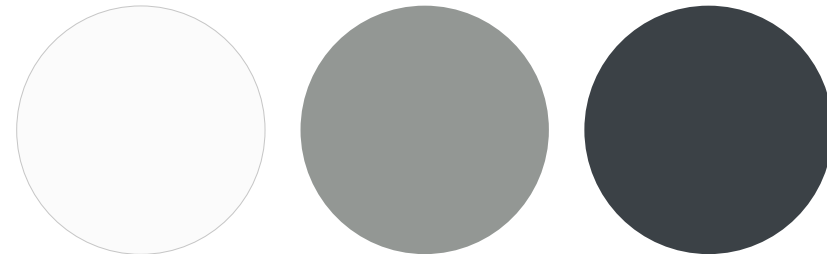

CA1 | OPACO BIANCO

CA2 | OPACO GRIGIO PIETRA

CA3 | OPACO ANTRACITE

**GLOSS** Finitura extra lucida / Extra glossy finish / Finition extra brillante

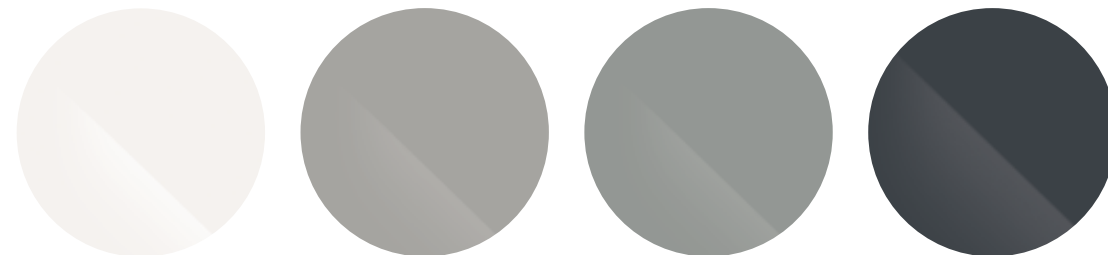

DA1 | LUCIDO BIANCO

DA2 | LUCIDO GRIGIO SETA

DA3 | LUCIDO GRIGIO PIETRA

DA4 | LUCIDO ANTRACITE

**LACCATO UV EASYLAK è un'innovativa finitura laccata lucida e opaca soft touch.**

La sua unicità nasce dal fatto che affianca all'elegante bellezza del gloss e alla piacevolezza tattile dell'effetto seta una serie di qualità nascoste, capaci di fare la differenza sul piano delle performance.

- Resistenza all'abrasione e alla graffiatura
- Elevata resistenza chimica
- Bassissime emissioni di VOC
- Riparabilità di piccoli graffi mediante un semplice e immediato procedimento termico.

**EASYLAK UV LACQUER is an innovative glossy and Matt soft touch lacquered finish.**

It is unique in that it combines the sophistication of gloss and the tactile pleasantness of the silk effect with a series of hidden qualities that improve performance.

- Resistance to abrasion and scratching
- High chemical resistance
- Very low VOC emissions
- Repairability of small scratches by means of a simple and immediate thermal process.

**Le LAQUÉ UV EASYLAK est une finition laquée innovante brillante et mate douce au toucher.**

Son caractère unique tient au fait qu'il allie la beauté élégante du brillant et la douceur tactile de l'effet soie à une série de qualités cachées, capables de faire la différence en termes de performances.

- Résistance à l'abrasion et aux rayures
- Haute résistance chimique
- Très faibles émissions de COV
- Possibilité de réparation des petites rayures au moyen d'un simple et processus thermique immédiat.

## Laccati lucidi e opachi sp.22mm

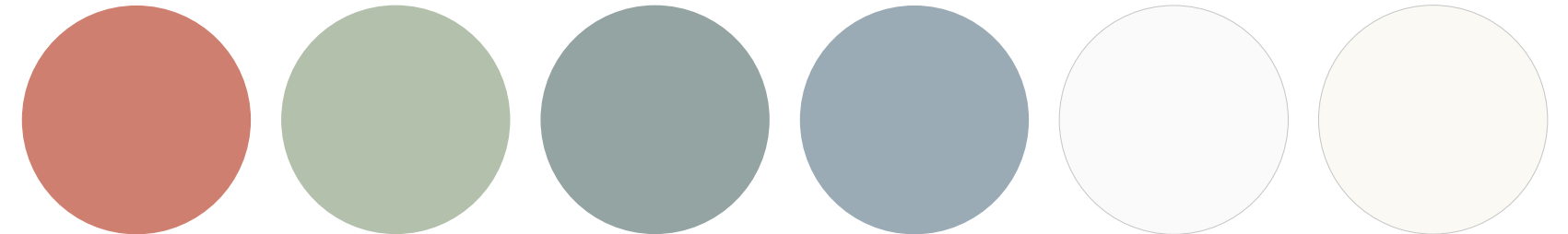
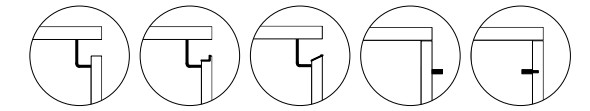

O37 opaco / U34 lucido  
MAGNOLIA

O41 opaco / U36 lucido  
MENTA

O26 opaco / U21 lucido  
GIADA

O35 opaco / U29 lucido  
LUCE

O04 opaco / U06 lucido  
BIANCO

O11 opaco / U07 lucido  
NEVE

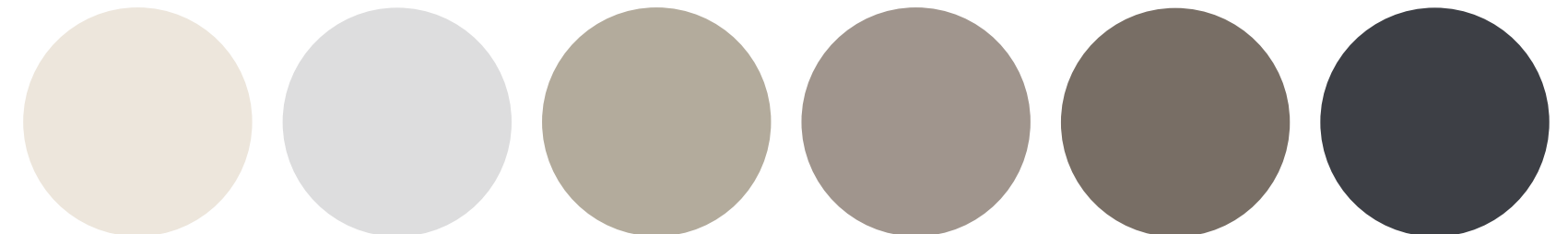

O36 opaco / U31 lucido  
MADREPERLA

O31 opaco / U25 lucido  
GRIGIO

O57 opaco / U54 lucido  
SALIS

O52 opaco / U52 lucido  
SABBIA

O22 opaco / U18 lucido  
FANGO

O32 opaco / U03 lucido  
ANTRACITE

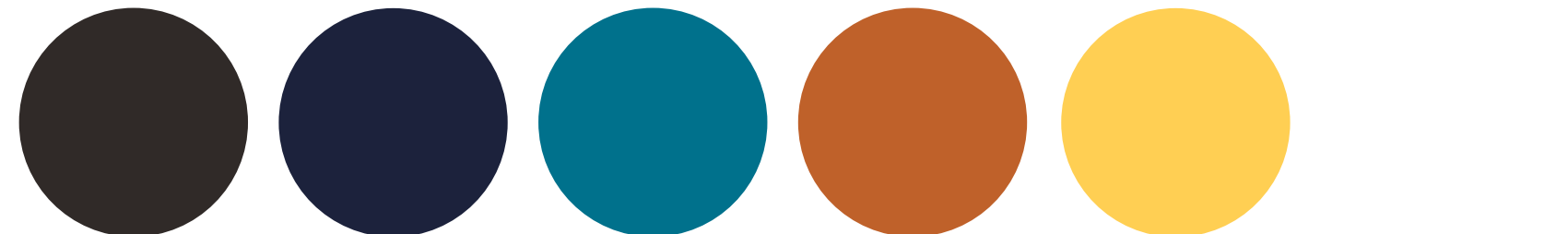

O44 opaco / U33 lucido  
MOKA

O12 opaco / U41 lucido  
BLU NOTTE

O46 opaco / U42 lucido  
BLU OCEANO

O52 opaco / U48 lucido  
RUGGINE

O43 opaco / U32 lucido  
MANGO

## Decorativi sp.22mm

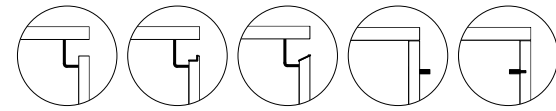

### DECORATIVI LEGNO / WOOD / BOIS



K07 | NOCE SIDER



I06 | NOCE GREY



D07 | NOCE LLOYD



I07 | NOCE LAVA



K06 | NOCE COTTO



D01 | NOCE CANALETTO

### DECORATIVI TEXTURE / TEXTURE / TEXTURES



EA1 | GESSATO BIANCO



EA2 | GESSATO MADREPERLA



EA3 | BETON MADREPERLA



EA4 | BETON SABBIA

### DECORATIVI SINCROPORO / SYNCHROPOROUS / SYNCHROPOREUSES



I03 | ROVERE NODATO



I04 | BIANCO NODATO

### DECORATIVI COLORE / COLOR / COULEUR



K15 | PLATINO

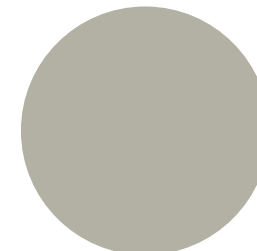

K16 | SALIS

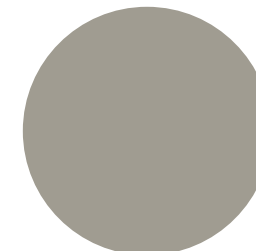

K14 | SABBIA

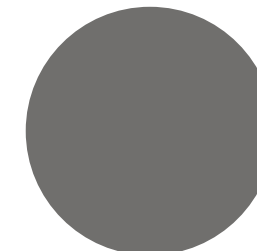

K17 | GRAFITE

**Tinte morbide che si avvicinano alle finiture del legno sino ad essere interpretate come materiali lignei veri e propri.**

Qualità e prezzo sono la base di partenza di questi prodotti: la gamma si amplia con l'inserimento dei nuovi Noce Cotto e Noce Sider.

**Light shades, that remind wood finishes, can be interpreted as real wooden panels.**

Value for money is at heart of our products. New colours "Noce Cotto" and "Noce Sider" have been added to our finish selection.

**Des couleurs douces qui se rapprochent tellement des finitions en bois qu'elles peuvent être interprétées comme de véritables matériaux en bois.**

La qualité et le prix sont la base de ces produits: la gamme s'élargit avec l'ajout des nouveaux noyer Cotto et noyer Sider.



**Essenze** sp.22mm

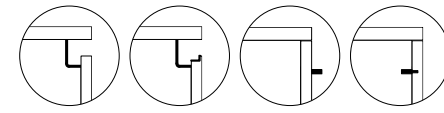

**ESSENZE / WOODS / ESSENCES**



W10 | ROVERE BIANCO



W07 | ROVERE GRAFITE



W08 | ROVERE CACAO



W09 | ROVERE YUTA

**ESSENZE DOGATE / WOODS WITH SLATTED EFFECT / ESSENCES DOGATE**



WA1 | ROVERE BIANCO



WA2 | ROVERE GRAFITE



WA3 | ROVERE CACAO



WA4 | ROVERE YUTA

**HPL** sp.22mm

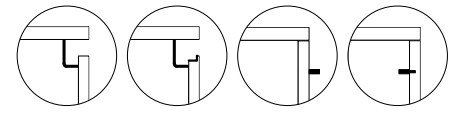

H01 | BRONZO



H02 | LAMIERA



H03 | BIANCO



H04 | CALACATTA



H05 | GRAFITE BROWN



H12 | FERRO

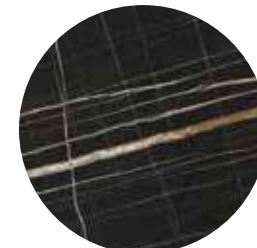

H11 | MARMO AFGANO



H13 | MALTA



H06 | GREY STONE

**Pannelli costituiti da strati di materiale di fibra cellulosa impregnati di resine termoindurenti.**

HPL è un laminato stratificato creato per azzerare i danni causati dall'acqua, dal vapore e dalle infiltrazioni degli olii, permettendo di evitare giunzioni e con la possibilità di dimensioni e forme finora non consentite da altri materiali.

**HPL stratified laminated panels are made of layers of cellulose fibre materials which are impregnated with thermosetting resins.**

This kind of stratified laminate is created in order to eliminate the damages caused by water, steam and oil infiltrations. This material allows the avoidance of joints and the possibility to have sizes and shapes, which were not possible in the past and with other materials.

**Panneaux constitués de couches de fibres de celluloses imprégnées de résines thermodurcissables.**

HPL est un stratifié en couches créé pour éliminer les dommages causés par les infiltrations d'eau, de vapeur et d'huile, permettant d'éviter les joints, avec la possibilité de proposer dimensions et de formes non autorisées auparavant par d'autres matériaux.

**Fenix** sp.22mm

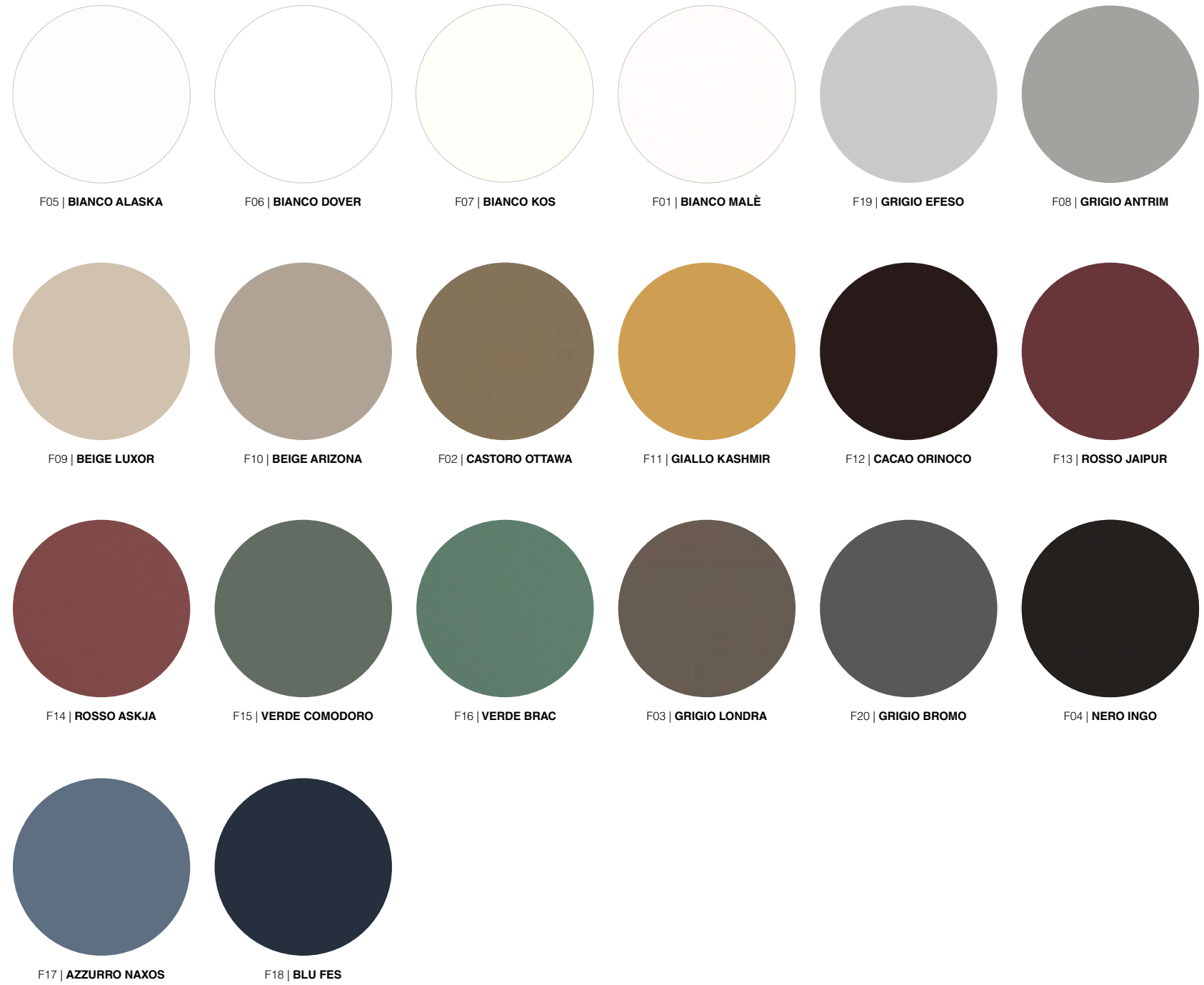
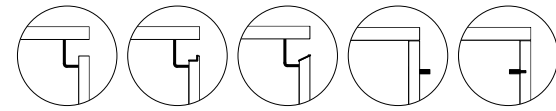

**Laccati acciaio** sp.22mm

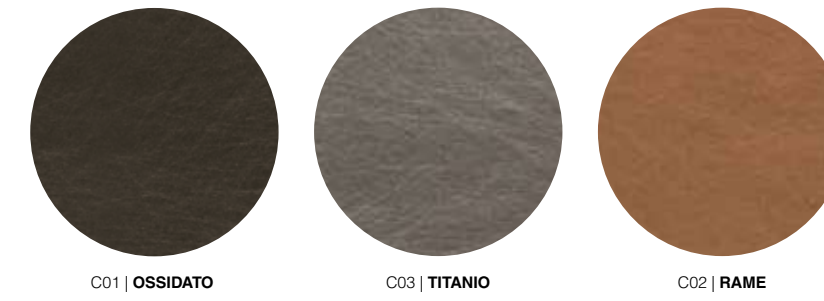
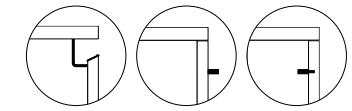

**FENIX NTM® è un materiale innovativo creato per l'interior design, adatto ad applicazioni sia verticali sia orizzontali.**

Con una bassa riflessione della luce, la sua superficie è estremamente opaca, anti impronte digitali e piacevolmente soft touch. Igienico, idoneo al contatto con gli alimenti, facile da pulire, antimuffa e idrorepellente: ecco le caratteristiche che lo rendono particolarmente adatto all'ambiente cucina.

**FENIX NTM® is an innovative material created for interior design and suitable for both vertical and horizontal applications.**

With low light reflectivity, the surface is extremely opaque, anti-fingerprint and pleasantly soft to the touch. Hygienic, suitable for contact with food, easy to clean, anti-mould and water-repellent: these are the characteristics that make it particularly suitable for the kitchen environment.

**FENIX NTM® est un matériau innovant créé pour la décoration intérieure, adapté aux applications verticales et horizontales.**

Avec sa faible réflexion lumineuse, sa surface est extrêmement opaque, anti-traces de doigts et est agréablement douce au toucher. Hygiénique, adapté au contact avec les aliments, facile à nettoyer, anti-moisissure et hydrofuge: ces caractéristiques rendent ce matériau particulièrement adapté à l'environnement de la cuisine.



## Resina Malta Ecologica

sp.22mm

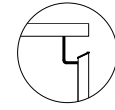

M02 | TORTORA



M03 | CEMENTO



M01 | ARDESIA

## PET

sp.22mm

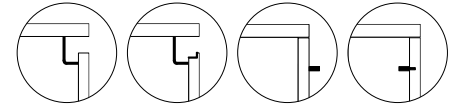

Q01 | BIANCO

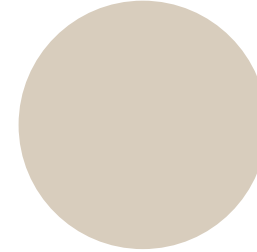

Q03 | CASHMERE

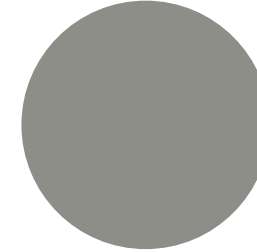

Q04 | GRIGIO POLVERE

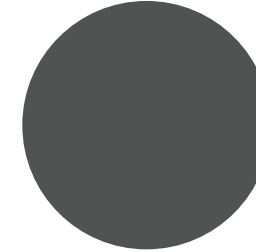

Q05 | GRAFITE

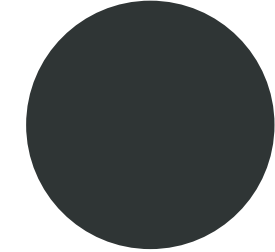

Q06 | NERO

### GreenPET, il nuovo pannello PET ecologico.

Un innovativo pannello realizzato con fogli di PET derivati da bottiglie di plastica riciclate.

### GreenPET, the new ecological PET panel.

An innovative panel made with sheets of PET created with recycled plastic bottles.

### GreenPET, le nouveau panneau PET écologique.

Un panneau innovant fait de feuilles PET issues de bouteilles en plastique recyclées.

# Vetri laccati lucidi e opachi / Gres sp.22mm

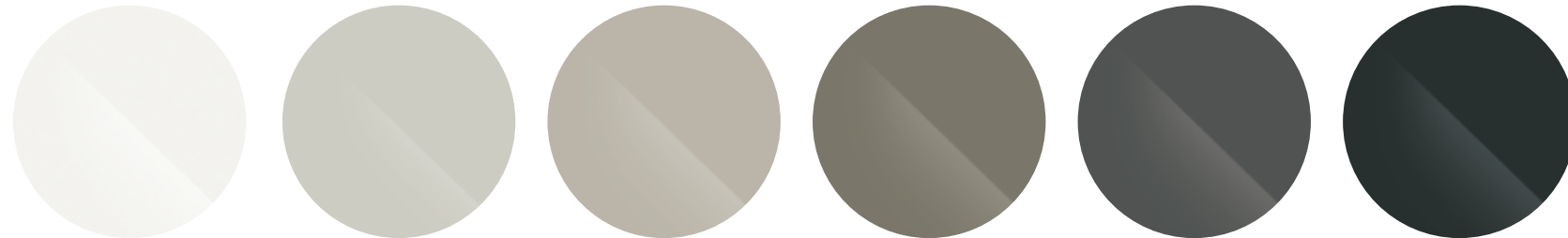

Z02 opaco / ZA1 lucido  
**BIANCO**

Z08 opaco / ZA2 lucido  
**GRIGIO**

Z09 opaco / ZA3 lucido  
**TORTORA**

Z10 opaco / ZA4 lucido  
**GLASS**

Z11 opaco / ZA5 lucido  
**GRAFITE**

Z06 opaco / ZA6 lucido  
**NERO**

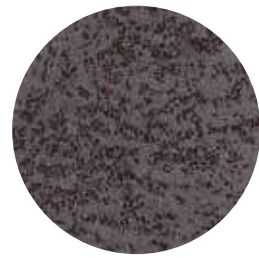

Z12 opaco / ZA7 lucido  
**OXIDE NERO**

# Anta Vetrina "Luxury"

VETRO / GLASS / VERRE

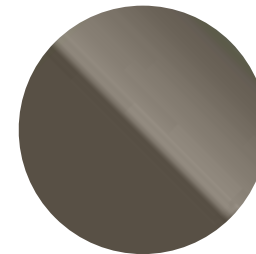

ZB1 | **FUMÈ**

Finiture telaio / frame finishes / finitions cadre



**NERO SPAZZOLATO** / BRUSHED BLACK / NOIR BROSSÉ

**NERO OPACO** / MATT BLACK / NOIR MAT

**BIANCO OPACO** / MATT WHITE / BLANC MAT

**BRILL** / BRILL / BRILLANT



Finiture telaio / frame finishes / finitions cadre



**ANTRACITE** / ANTHRACITE / ANTHRACITE

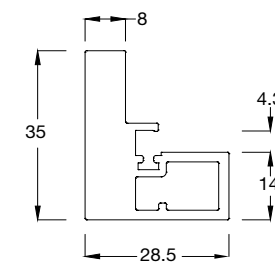

**Profilo anta** / Door profile / Profilé porte





## Gola e Zoccolo



ALB | LACCATA

Tinte laccati lucidi e opachi  
Glossy and matt lacquered  
Laqué brillant et mat



ASN | NERO SPAZZOLATO

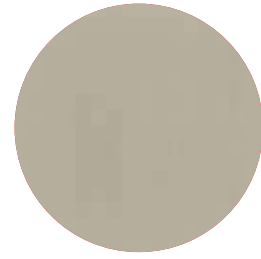

TIT | TITANIO

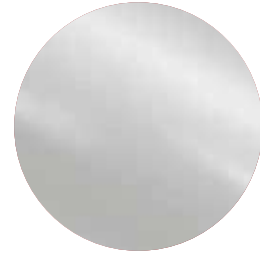

XAB | BRILL

## Struttura



A04 | NOCE COTTO

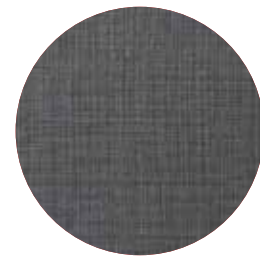

A03 | CANVAS ANTRACITE

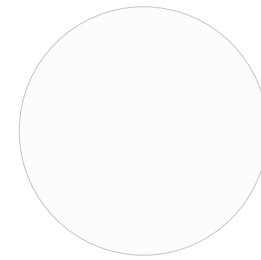

A01 | BIANCO

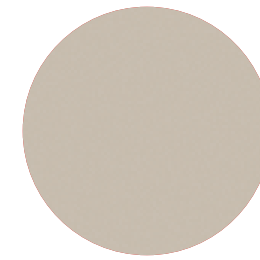

A02 | COLONIALE

GRAPHIC DESIGN — ELISA DE MARCHI  
PHOTO — KINETIX  
COLOUR SEPARATION — IMAGE  
PRINT — GRAFICHE GEMMA

**SPAGNOL CUCINE**

SEDE LEGALE:  
VIA VIDOR, 1  
31010 MOSNIGO DI MORIAGO  
(TREVISO) ITALY

TEL. +39 0438 89 11  
FAX +39 0438 89 00 82  
SPAGNOLCUCINE@LAMIAPEC.IT



SEDE OPERATIVA:  
VIA PALUDOTTI, 2  
31020 VIDOR  
(TREVISO) ITALY

TEL. +39 0423 98 87  
FAX +39 0423 98 88 19  
CUCINE@SPAGNOL.IT  
WWW.SPAGNOLCUCINE.IT

EXPORT DEPARTMENT:  
FAX +39 0423 988836  
EXPORT@SPAGNOL.IT



© MOBIL SRL  
Edition July 2020

431-SC-CAT.MARYLAND-06-20 Rev.0



spagnol.it