

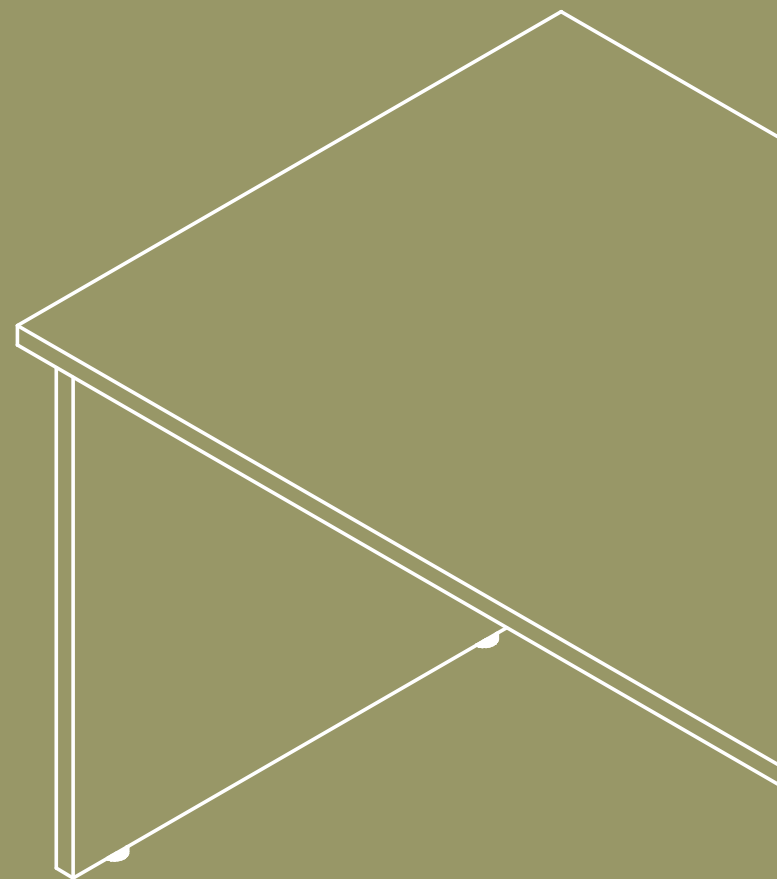

DERBY



DERBY





## DERBY

### GAMBA A "T" / "T" LEG

Derby è un sistema integrato per l'arredamento di uffici operativi e spazi condivisi che è stato progettato nell'ottica di un largo impiego, pensando alla grande funzionalità unita al design. La collezione di scrivanie, regolabili in altezza su richiesta, con la loro leggerezza strutturale e forme minimali ed eleganti, configura e personalizza con stile gli ambienti di lavoro contemporaneo.

Derby is an integrated system for furnishing operational offices and shared spaces. It has been designed for a wide range of uses, combining functionality with design. The desk collection, height-adjustable on request, features lightweight structure and elegant minimal forms, and stylishly characterizes and customises contemporary office environments.



Derby con gamba a "T": una collezione versatile per postazioni di lavoro e tavoli riunione  
Derby with "T" leg: a versatile collection for workstations and meeting tables



I mobili di servizio su ruote sono una soluzione molto funzionale. Infatti, consentono di compattare lo spazio di archiviazione in prossimità della postazione di lavoro, e possono essere facilmente spostati.

The super-functional service units on wheels provide compact filing space near the workstation and can be easily moved.

I piani in melaminico hanno spessore 25 mm  
Gli angoli dei piani possono essere sia dritti, sia raggiati.  
Le gambe sono disponibili in tre colori: bianco, grigio alluminio e antracite e presentano anche una soluzione regolabile in altezza.

Thickness of melamine tops: 25 mm.  
The tops can have straight or rounded corners.  
The legs come in three colours: white, aluminium grey and anthracite, and also comprise height-adjustable solution.





Le workstation sono pensate per essere accessoriate con screen divisori. Questi ultimi possono occupare tutta la larghezza del piano oppure essere rientranti. I piani scrivania, nell'immagine a lato, sono sagomati e dotati di cassetteria fissa portante.

The workstations are designed to be accessorised with dividers. These can provide complete or partial screening. The desk tops (see photo at the side) are shaped and provided with fixed supporting drawer unit.

Le stesse scrivanie con piano sagomato sono disponibili anche con cassetteria su ruote a quattro cassetti con serratura.

The same desks with shaped top are also available with drawer unit on wheels with four lockable drawers.







Le postazioni allineate ed i bench sono dotati di gambe centrali condivise, riducendo al minimo i componenti strutturali.

The in-line workstations and benches are provided with shared central legs, minimising the number of structural components.

Le gambe possono essere fisse o regolabili in altezza, con un'escursione di 10 cm, consentendo di adattare le scrivanie alle diverse esigenze ergonomiche degli utenti.

The legs can be fixed or height-adjustable, over a range of 10 cm, so that the desks can be adapted to different ergonomic requirements.





## Tanti accessori per personalizzare la tua postazione A whole range of accessories to customise your workstation

Ogni postazione può essere arricchita da accessori che rendono più funzionale il posto di lavoro. Screen in melaminico o tessuto, portacomputer sospeso o su ruote, passacavi e top access per collegare i vari dispositivi con pulizia e ordine. Diversi optional anche per i mobili: ad esempio le ante con l'apertura "push and pull", al tempo stesso comode e dal design minimal. Un dettaglio interessante sono le cerniere ammortizzate, che rendono piacevole e duraturo il loro utilizzo.

Each workstation can be enhanced with accessories for even greater functionality. Melamine or fabric screen, CPU support suspended or on wheels, desk grommets and top access for connecting various devices and keeping them clean and tidy. Various optionals are available also for the furniture: for example doors with push-pull opening, a handy solution with minimalist design. The hinges with soft closing, for easy use and long life, are another interesting detail.











Le scrivanie Derby possono essere dotate di allungo laterale con cassetteria fissa portante oppure con cassetteria su ruote a tre o quattro cassetti.  
Nella parte anteriore della scrivania è possibile applicare come optional un modesty panel.

The Derby desks can be provided with side extension with fixed supporting drawer unit or with drawer unit on wheels with three or four drawers.  
A modesty panel can be fitted as an optional at the front of the desk.

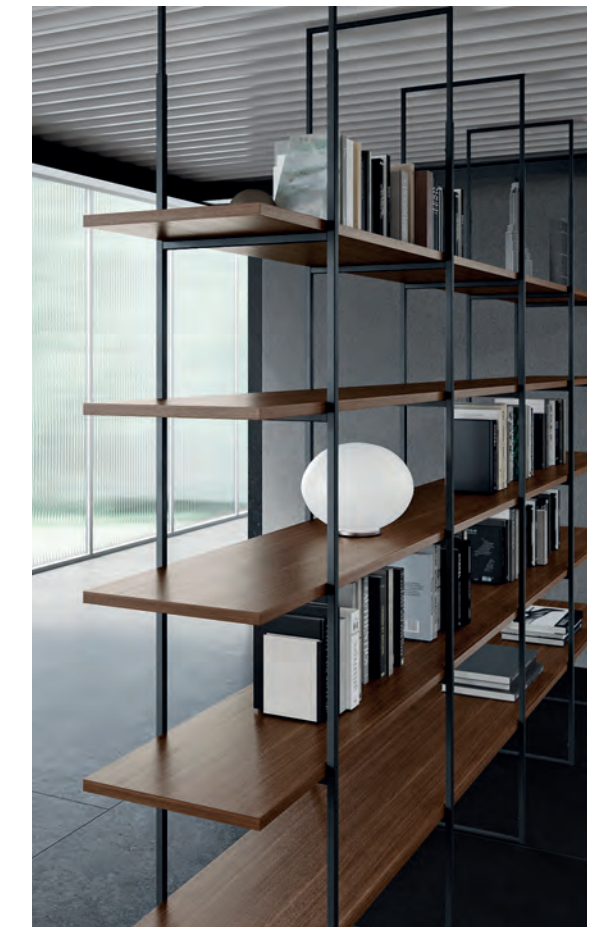



La serie Derby prevede differenti tavoli riunione, dal semplice tavolo con gambone centrale a tavoli più ampi, con piani di diverse sagomature: rettangolari, ovali ed ellittiche. I colori e le finiture possono essere combinati tra loro con giochi di armonia o di contrasto.

The Derby range comprises different meeting tables, from simple tables with central leg to larger tables, with different shaped tops: rectangular, oval and elliptical. The colours and finishes can be combined to create matching or contrasting effects.











## DERBY

### PANNELLATA / PANELLED

Derby pannellata è una linea operativa che si distingue per la sua particolare essenzialità e semplicità. La collezione di scrivanie è estremamente funzionale nelle postazioni di lavoro condivise. Il sistema prevede elementi modulari che permettono un'ampia aggregabilità in molteplici tipologie di lavoro. Forme, colori e materiali possono essere combinati tra loro per rendere l'arredo unico ed originale.

Derby panelled is an operational line featuring a particularly simple clean-cut design. The desk collection is extremely functional in shared workstations. The system comprises modular elements that can be combined in all sorts of different ways to meet multiple office needs.

Forms, colours and materials can be blended to create unique original furnishing solutions.



Derby pannellata: il classico che si adatta a qualsiasi esigenza di lay-out  
Derby panelled: a classic that adapts to any layout

Postazioni essenziali, flessibili e funzionali, che grazie alla varietà dei contenitori, disponibili in diverse altezze e configurazioni, permettono di organizzare la postazione creando un alto livello di comfort.

Simple, flexible and functional workstations: the variety of containers, available in different heights and configurations, offers ample scope for organizing your workstation, creating a high level of comfort.

I mobili e le cassettiere della collezione Derby si arricchiscono di nuovi dettagli come ad esempio le maniglie dal design minimal disponibile in varie colorazioni.

The furniture and drawer units in the Derby collection are enhanced with new details like the handles with minimal design available in various colours



Le cassettiere su ruote si configurano in due soluzioni: a tre o quattro cassetti. Entrambe sono dotate di serratura.

The drawer units on wheels come in two solutions: with three or four drawers. Both are provided with lock.





Le linee essenziali permettono di giocare sugli abbinamenti tra piano e gamba per rendere l'arredo unico ed originale.

The simple lines allow you to combine the tops and legs to create unique original solutions.







La collezione Derby è adatta ad arredare gli spazi condivisi con stile e semplicità. Il sistema di scrivanie prevede anche la versione "call center", configurabile a fila singola o a file contrapposte. Entrambe le soluzioni possono ospitare screen in melaminico o tessuto e cablaggi per l'elettrificazione.

The Derby collection is ideal for furnishing shared spaces with style and simplicity. The desk system also comprises the call center version, which can be configured in single or opposite rows. Both solutions can be provided with melamine or fabric screen and cable management.





Ogni scrivania Derby è attrezzabile con elementi contenitivi a seconda delle diverse esigenze. Nella foto in alto, cassetiera portante a quattro cassetti con serratura.

Each Derby desk can be equipped with container elements as required. In the photo at the top, supporting drawer unit featuring four drawers with lock.

Nella foto a lato, quattro postazioni lavoro con screen che permette il contenimento ma anche la separazione delle diverse postazioni. Questa soluzione prevede cassettiere a tre cassetti, su ruote. È previsto inoltre un piano semicircolare di raccordo tra le scrivanie, con gambone a contrasto.

In the photo at the side, four workstations with screen for containment and also separation of the different stations. This solution comprises drawer units with three drawers, on wheels. A semicircular top is also provided joining the desks, with contrasting leg.









Anche nelle sale riunioni Derby soddisfa requisiti di funzionalità, comfort ed estetica. Le soluzioni proposte possono avere piani di differenti sagomature e misure.

Derby meets the need for functionality, comfort and aesthetics also in meeting rooms. The solutions proposed can have tops in different shapes and sizes











La collezione Derby comprende anche i banconi da reception caratterizzati da elementi semplici che, accostati tra di loro, definiscono lo spazio di primo contatto. Spazio che garantisce l'utilità sia per gli operatori che per il pubblico, senza compromettere l'estetica e la funzione della composizione realizzata. La reception può essere configurata anche per permettere una facile accessibilità ai disabili.

The Derby collection also comprises reception desks characterized by simple elements that can be positioned side-by-side to create a point of first contact. A utility space for both the operators and the public, without compromising the aesthetics and function of the composition. The reception desk can also be configured for easy wheelchair access.



# Optional



Top access da 42 cm in alluminio  
Aluminium cable outlet w.42 cm with cable tray



Passacavi da 24 cm con cablaggio elettrico e dati  
Top access w.24 cm with electrical power & data system



Top access da 42 cm  
Cable outlet w.42 cm with cable tray



Coppia morsetti per paretina singola  
Couple clamps for single desk frontal panel



Coppia morsetti per paretina condivisa  
Couple clamps for bench frontal panel



Ammortizzatore per cerniere  
Shock absorber for hinges



Passacavi da 24 cm - 32 cm  
Cable outlet w.24 cm - 32 cm



Boccola passacavi diam. 8 cm  
Cable porthole diam. 8 cm



Presca Schuko e USB diam. 8 cm senza trasformatore  
Schuko plug diam. 8 cm + usb data without electrical transformer



Optional: maniglia colore bianco  
Optional: white handle



Optional: maniglia colore antracite  
Optional: anthracite handle



Vaschetta poggiacavi sotto la scrivania  
Cable container below desk



Salita cavi verticale - Canala orizzontale 65 cm  
Vertical - horizontal cable running w.65 cm

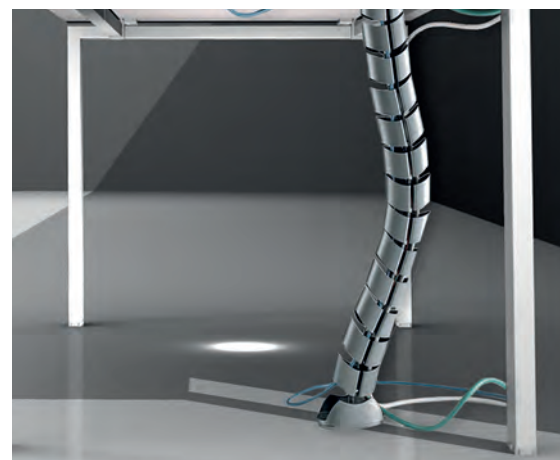

Vertebra passacavi  
Vertical cable running



Clip supporto cavi  
Cable holder



Antenna con apertura push & pull  
Door with push & pull opening



Porta computer su ruote  
Computer holder



Porta computer sospeso  
Computer holder



## Finiture piani e finiture cassa Tops finishing and structure finishing



rovere/finitura piani - finitura cassa  
oak/tops finishing - structure  
finishing



noce/finitura piani - finitura cassa  
walnut/tops finishing - structure  
finishing



ciliegio/finitura piani  
cherry/tops finishing



olmo/finitura piani - finitura cassa  
elm/tops finishing - structure  
finishing



samui/finitura piani - finitura cassa  
samui/tops finishing - structure  
finishing

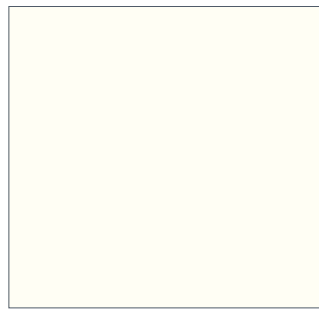

bianco/finitura piani - finitura cassa  
white/top finishing - structure  
finishing



grigio alluminio/finitura piani - finitura  
cassa  
aluminum gray/top finishing -  
structure finishing



antracite finitura piani - finitura cassa  
anthracite/top finishing - structure  
finishing

## Colori gamba a "T" "T" leg colours



bianco RAL 9010  
white RAL 9010



grigio alluminio RAL 9006  
aluminium grey RAL 9006



antracite RAL 7022  
anthracite RAL 7022

## Rivestimenti paretine Fabric coverings for partition screens

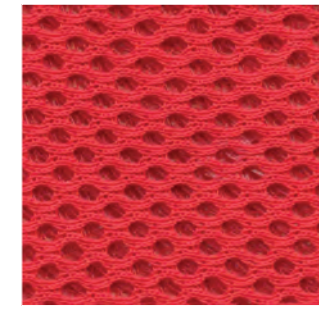

P 650

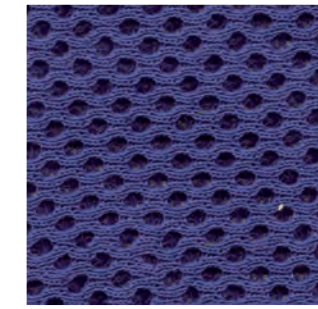

P 652

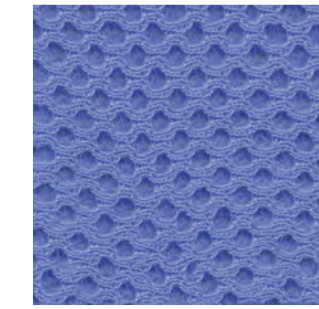

P 651

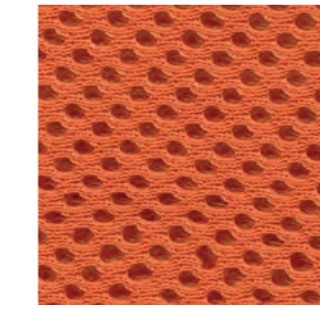

P 655

Tessuto ignifugo / Fireproof fabric



## Pannelli acustici fonoassorbenti Sound absorbing panels

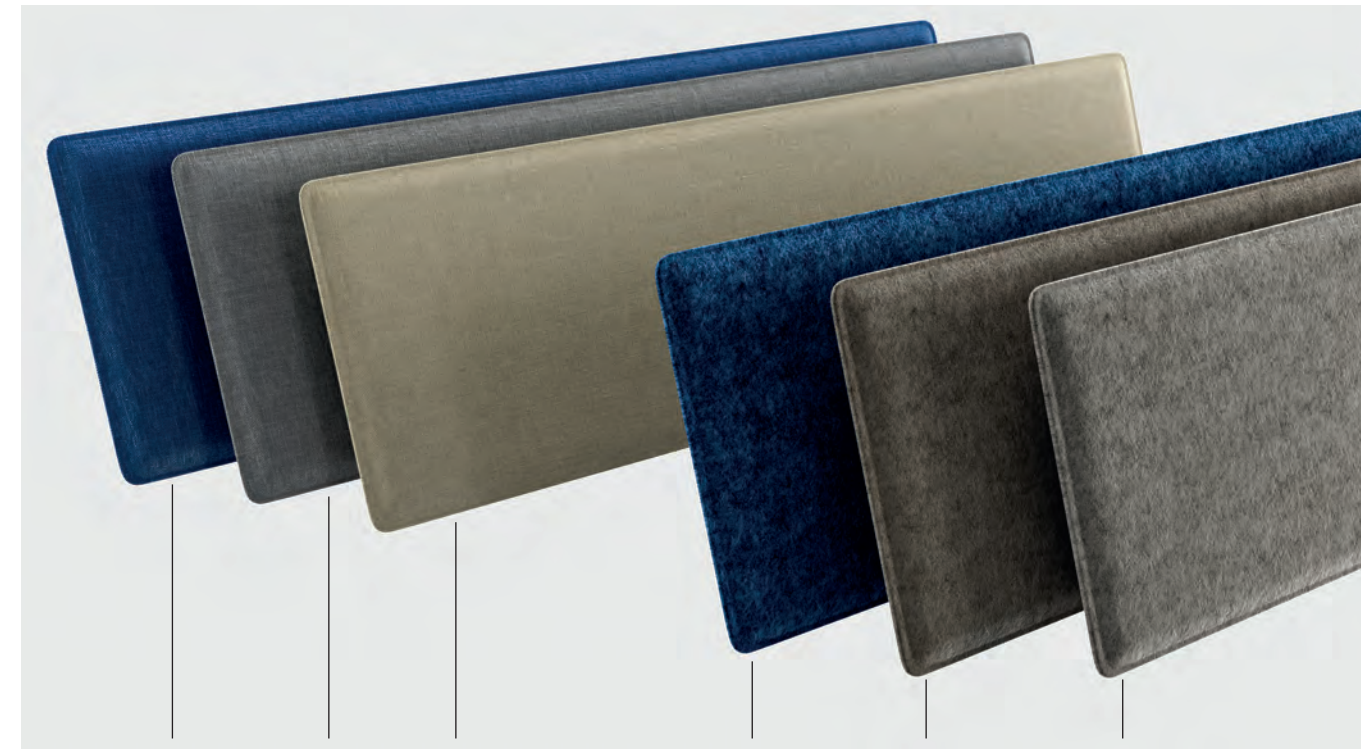

Blu  
Blue

Grigio  
Grey

Beige

Feltro blu  
Blue felt

Feltro grigio  
Grey felt

Feltro grigio chiaro  
Light grey felt



# Elementi tecnici

## Technical elements



80/100/120/140/160/180 x 80 x 75H



80/100/120/140 x 60 x 75H

100/120/140/160 x 60 x 75H

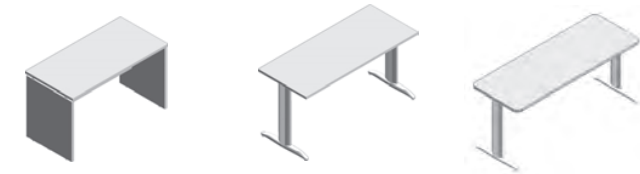

80/100/120/140/160 x 60 x 75H



160/160 x 80/60 x 75H



160/120 x 80/60 x 75H



41 x 80/60 x 75H

84 x 58 x 59H

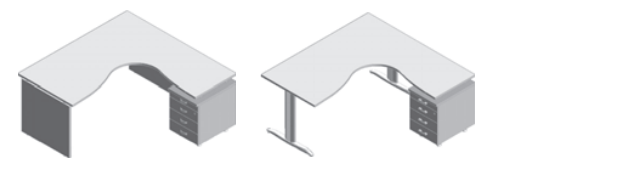

160/160 x 80/60 x 75H

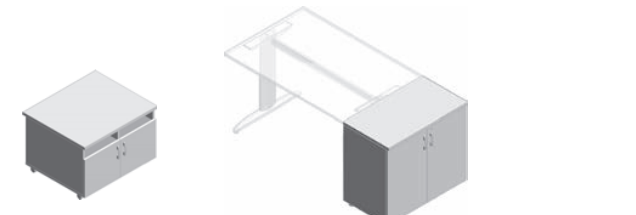

75 x 63 x 54

80 x 45 x 75H



41 x 56 x 50H

41 x 56 x 57H

41 x 56 x 57H

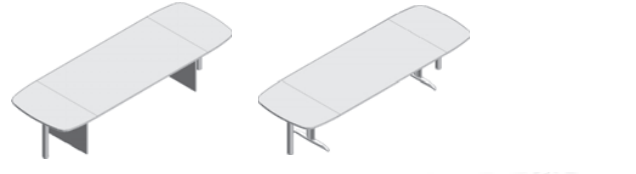

320/370 x 110 x 75H

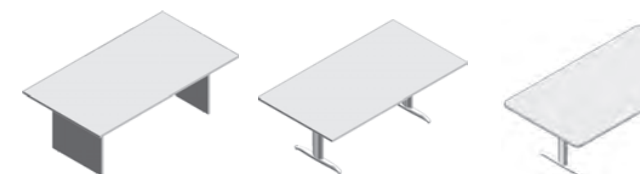

200/250 x 110 x 75H



80/100 x 64/127 x 103/131H

45 x 45 x 119/158H

80/120 x 24 x 65H

80/120 x 24 x 98H



210 x 125 x 75H

Ø100/120/130 x 75H

200/220 x 90/100/110 75H



180/200/220 x 90/100/110 75H

180/200/220 x 90/100/110 75H

180/200/220 x 90/100/110 75H

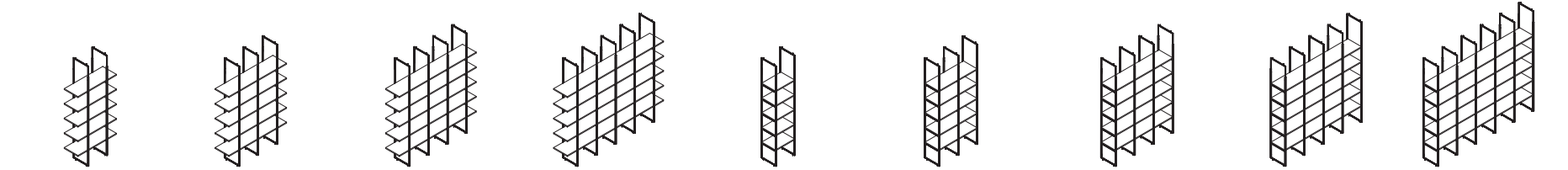

120x47x240-270H 180/200x47x240-270H 240/280x47x240-270H 300x47x240-270H 60/80x47x240-270H 120/160x47x240-270H 180/240x47x240-270H 240/320x47x240-270H 300x47x 240-270H

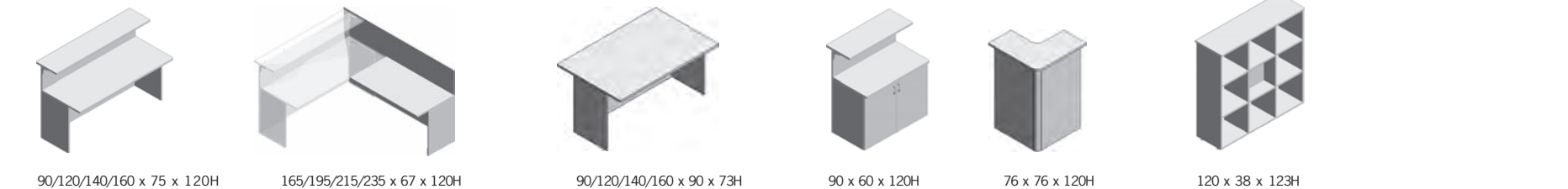

90/120/140/160 x 75 x 120H 165/195/215/235 x 67 x 120H 90/120/140/160 x 90 x 73H 90 x 60 x 120H 76 x 76 x 120H 120 x 38 x 123H

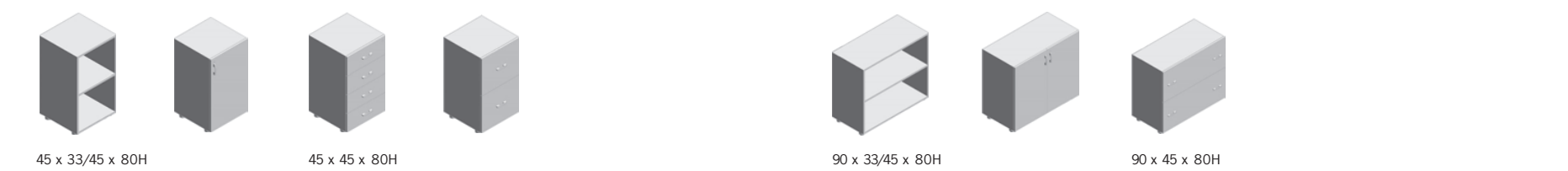

45 x 33/45 x 80H 45 x 45 x 80H 90 x 33/45 x 80H 90 x 45 x 80H



45 x 33/45 x 119H 90 x 33/45 x 119H



45 x 33/45 x 196H 45 x 45 x 196H 90 x 33/45 x 196H 90 x 45 x 196H

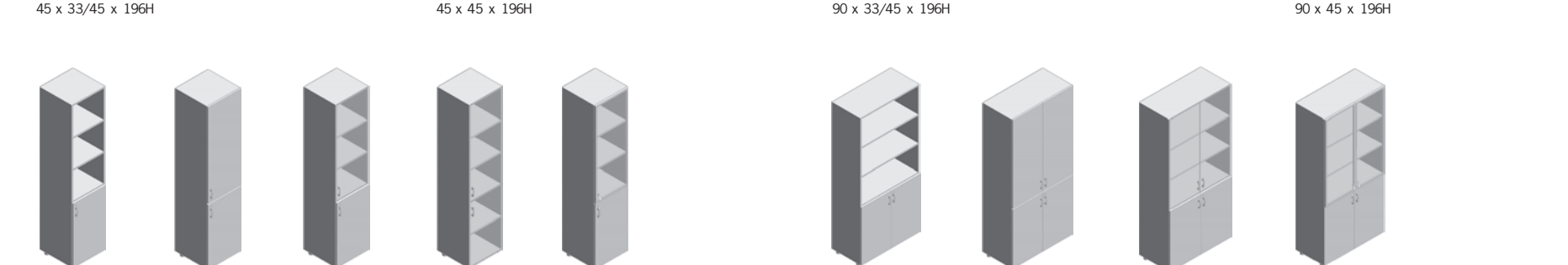

45 x 45 x 196H 90 x 45 x 196H

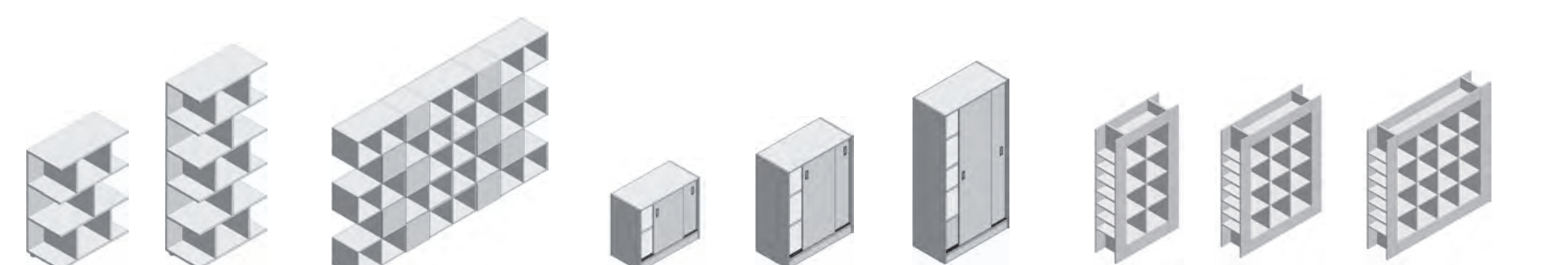

90 x 45 x 121H 90 x 45 x 198H 320 x 45 x 201H 120 x 50 x 90H 120 x 50 x 130H 120 x 50 x 200H 122 x 40 x 206H 164 x 40 x 206H 206 x 40 x 206H



COMPIR S.r.l.  
C.da Mannanici S.N.  
95048 Scordia (CT)  
ITALY

T. +39 (0) 95 7937011  
T. +39 (0) 95 7935015

commerciale@compir.it  
www.compir.it

A.D. immagina.biz  
3D images: Giuseppe Difilippo  
Printed by: Tipografia Priulla  
Edition: 09/2023

COMPIR si riserva la facoltà di modificare, in qualunque momento e senza preavviso, le caratteristiche tecniche degli elementi illustrati nel presente catalogo. Declina ogni responsabilità per eventuali inesattezze contenute nello stesso.

COMPIR has the right to modify anytime and without previous notice the technical characteristics of the elements illustrated in this catalogue and declines any responsibility for any possible inaccuracies present in this catalogue.



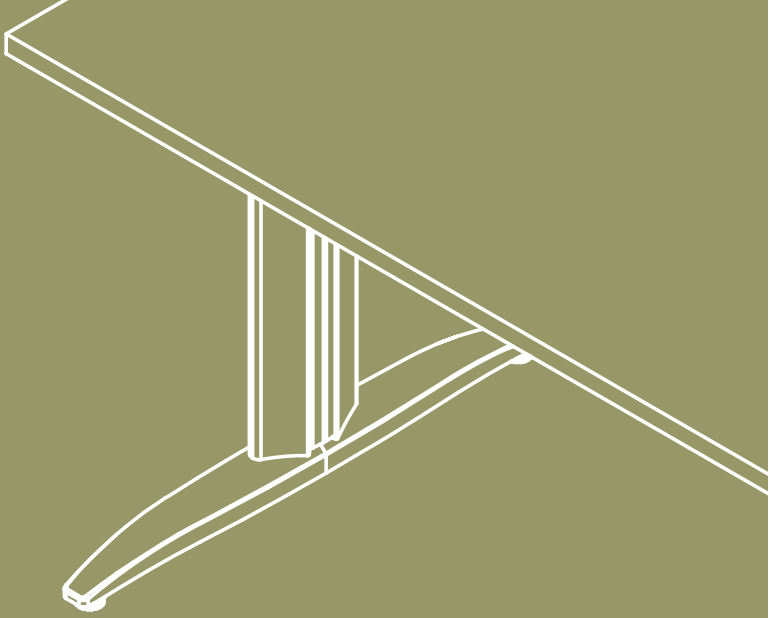

40  
ANNI/YEARS  
*compir*

 FLYCOM®